

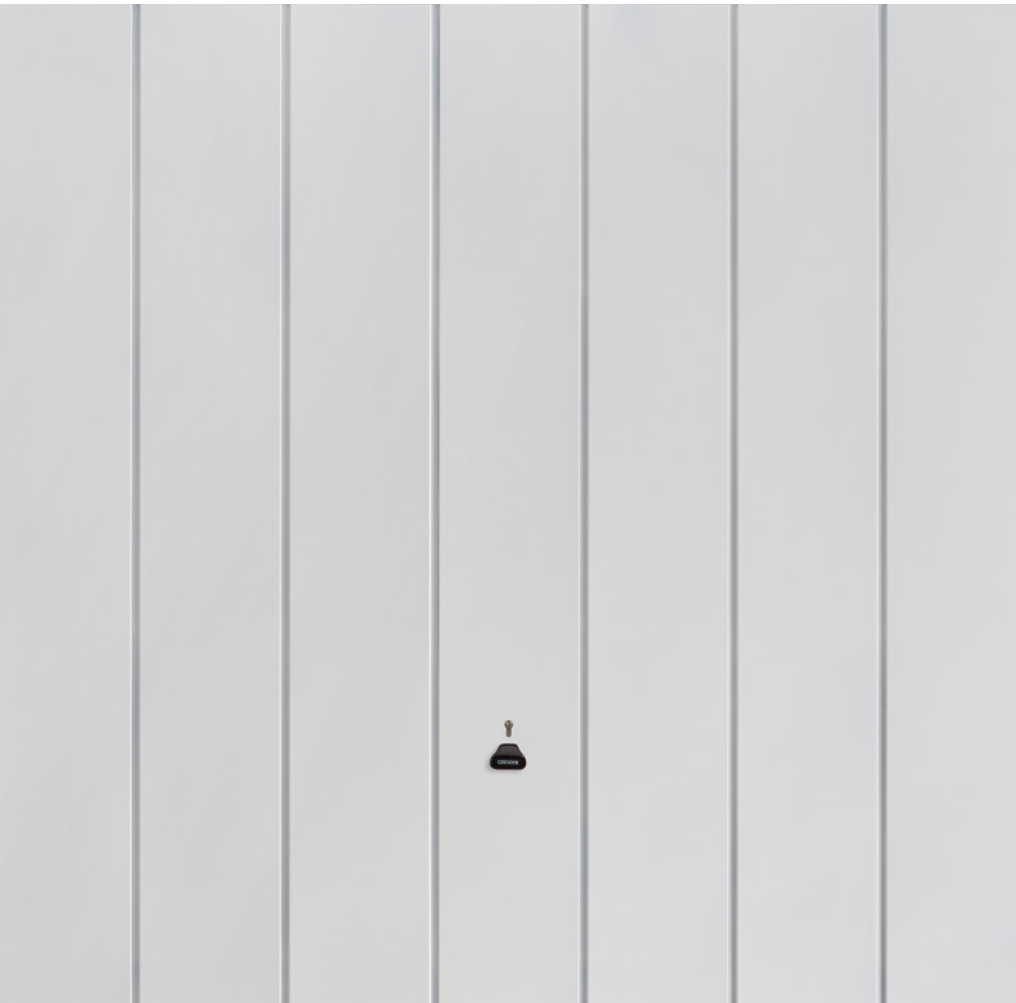

# The Garador Range Price List

**1<sup>st</sup> March 2025**

Garage Doors and Automatic Operators



# General Information

All prices are quoted in £ Sterling, ex-works and exclusive of VAT.

Our doors are for residential purposes only and not for commercial use.

Please ensure that you order the correct size door to fit your opening as we are unable to accept the return of incorrectly ordered goods. Please contact Garador on 01935 443722 if you need assistance in calculating the correct size. A comprehensive range of the less common accessories and all spare parts are available either online or ask for a current spares price list if required.

Since the company's policy is one of continuous improvement of its products, we reserve the right to make any alterations in design, manufacture or price.

All business is governed by the Company's Standard Conditions and this document does not form any part of any contract with the company and statements contained in it should not be construed as representations or warranties.

For more information please visit  
[www.garador.co.uk](http://www.garador.co.uk)



# Contents

Frame Dimensions for Panel Doors	4
Steel Panel Doors	6
Guardian Range	16
Design Range	18
GRP Premier Panel Doors	20
Timber Panel Doors	26
Steel and Timber Garage Side Doors	36
Steel and Timber Side-hinged Doors	38
Garage Side Doors & Side-hinged Doors – Specifications	44
Steel Panel Doors – Specifications	45
Steel Sectional Garage Doors	48
Automation and Accessories	72
GaraRoll Roller Doors	78
GaraGlide Roller Doors	82
User Information / Care	86
Warranty	88
Extracts from DHF consumer advice	90

# Frame Dimensions for Panel Doors

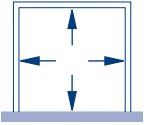
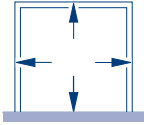
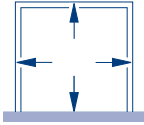
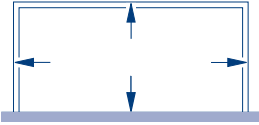
Size Code				
	Internal frame size On-site timber frame Width x Height (mm x mm)	Pre-framed canopy door overall frame sizes shown <sup>1</sup> Width x Height (mm x mm)	Pre-framed retractable door overall frame sizes shown <sup>1</sup> Width x Height (mm x mm)	Frame kit for double door overall frame sizes shown <sup>1</sup> Width x Height (mm x mm)
6660	1984 x 1830	2094 x 1888	2124 x 1888	-
6663	1984 x 1905	2094 x 1963	2124 x 1963	-
6664	1984 x 1931	2094 x 1989	2124 x 1989	-
6666	1984 x 1981	2094 x 2039	2124 x 2039	-
6670	1984 x 2136	2094 x 2194	2124 x 2194	-
61064	2084 x 1931	2194 x 1989	2224 x 1989	-
61066	2084 x 1981	2194 x 2039	2224 x 2039	-
61070	2084 x 2136	2194 x 2194	2224 x 2194	-
7060	2134 x 1830	2244 x 1888	2274 x 1888	-
7063	2134 x 1905	2244 x 1963	2274 x 1963	-
7064	2134 x 1931	2244 x 1989	2274 x 1989	-
7066	2134 x 1981	2244 x 2039	2274 x 2039	-
7068	2134 x 2036	2244 x 2094	2274 x 2094	-
7070	2134 x 2136	2244 x 2194	2274 x 2194	-
7072	2134 x 2186	2134 x 2244	2274 x 2244	-
7076	2134 x 2286	-	2274 x 2344	-
7163	2170 x 1905	2280 x 1963	2310 x 1963	-
7164	2170 x 1931	2280 x 1989	2310 x 1989	-
7166	2170 x 1981	2280 x 2039	2310 x 2039	-
7168	2170 x 2036	2280 x 2094	2310 x 2094	-
7170	2170 x 2136	2280 x 2194	2310 x 2194	-
7172	2170 x 2186	2280 x 2244	2310 x 2244	-
7176	2170 x 2286	-	2310 x 2344	-
7364	2224 x 1931	2334 x 1989	2364 x 1989	-
7366	2224 x 1981	2334 x 2039	2364 x 2039	-
7368	2224 x 2036	2334 x 2094	2364 x 2094	-
7370	2224 x 2136	2334 x 2244	2364 x 2194	-
7563	2259 x 1905	2369 x 1963	2399 x 1963	-
7564	2259 x 1931	2369 x 1989	2399 x 1989	-
7566	2259 x 1981	2369 x 2039	2399 x 2039	-
7568	2259 x 2036	2369 x 2094	2399 x 2094	-
7570	2259 x 2136	2369 x 2194	2399 x 2194	-
7572	2259 x 2186	2369 x 2244	2399 x 2244	-
7576	2259 x 2286	-	2399 x 2344	-
7663	2284 x 1905	2394 x 1963	2424 x 1963	-
7664	2284 x 1931	2394 x 1989	2424 x 1989	-
7666	2284 x 1981	2394 x 2039	2424 x 2039	-
7668	2284 x 2036	2394 x 2094	2424 x 2094	-
7670	2284 x 2136	2394 x 2194	2424 x 2194	-
7672	2284 x 2186	2394 x 2244	2424 x 2244	-
7676	2284 x 2286	-	2424 x 2344	-
8063	2439 x 1905	2549 x 1963	2579 x 1963	-
8064	2439 x 1931	2549 x 1989	2579 x 1989	-
8066	2439 x 1981	2549 x 2039	2579 x 2039	-
8068	2439 x 2036	2549 x 2094	2579 x 2094	-
8070	2439 x 2136	2549 x 2194	2579 x 2194	-

<sup>1</sup> No fitting clearance allowed. If door is fitted between the brickwork a minimum of 10 mm clearance over the width and 5 mm over the height should be added to the overall frame size when selecting the door.

GARADOR Frame Dimensions for Panel Doors

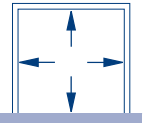
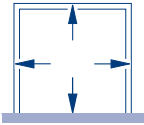
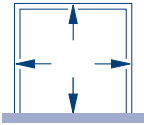
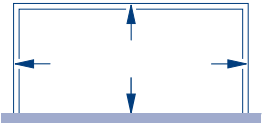
Size Code	 Internal frame size On-site timber frame Width x Height (mm x mm)	 Pre-framed canopy door overall frame sizes shown <sup>1</sup> Width x Height (mm x mm)	 Pre-framed retractable door overall frame sizes shown <sup>1</sup> Width x Height (mm x mm)	 Frame kit for double door overall frame sizes shown <sup>1</sup> Width x Height (mm x mm)
8072	2439 x 2186	2549 x 2244	2579 x 2244	–
8076	2439 x 2286	–	2579 x 2344	–
8666	2590 x 1981	–	2730 x 2039	–
8670	2590 x 2136	–	2730 x 2194	–
8676	2590 x 2286	–	2730 x 2344	–
9066	2744 x 1981	–	2884 x 2039	–
9070	2744 x 2136	–	2884 x 2194	–
9076	2744 x 2286	–	2884 x 2344	–
1066	3049 x 1981	–	3189 x 2039	–
1070	3049 x 2136	–	3189 x 2194	–
1076	3049 x 2286	–	–	3189 x 2344
1166	3354 x 1981	–	–	3494 x 2039
1170	3354 x 2136	–	–	3494 x 2194
1176	3354 x 2286	–	–	3494 x 2344
1266	3659 x 1981	–	–	3799 x 2039
1270	3659 x 2136	–	–	3799 x 2194
1276	3659 x 2286	–	–	3799 x 2344
1366	3964 x 1981	–	–	4104 x 2039
1370	3964 x 2136	–	–	4104 x 2194
1376	3964 x 2286	–	–	4104 x 2344
1466	4269 x 1981	–	–	4409 x 2039
1468	4269 x 2036	–	–	4409 x 2094
1470	4269 x 2136	–	–	4409 x 2194
1472	4269 x 2186	–	–	4409 x 2244
1476	4267 x 2186	–	–	4409 x 2244
1566	4574 x 1981	–	–	4714 x 2039
1570	4574 x 2136	–	–	4714 x 2194
1666	4879 x 1981	–	–	5019 x 2039
1670	4879 x 2136	–	–	5019 x 2194

<sup>1</sup> No fitting clearance allowed. If door is fitted between the brickwork a minimum of 10 mm clearance over the width and 5 mm over the height should be added to the overall frame size when selecting the door.

# Steel Panel Doors

## Surface

High quality powder or foil coated finish.

Please note: panel doors are produced with appearance in mind. This may result in some small gaps which could allow water ingress especially in exposed locations.

## Colours

All doors supplied in Traffic White (RAL 9016) as standard.

Optional colours available:

- Light Ivory (RAL 1015)	- Pigeon Blue (RAL 5014)	- Anthracite Grey (RAL 7016)	- Burgundy Brown
- Ruby Red (RAL 3003)	- Moss Green (RAL 6005)	- Terra Brown (RAL 8028)	- Golden Brown
- Signal Blue (RAL 5005)	- Fir Green (RAL 6009)	- Jet Black (RAL 9005)	- Chartwell Green (BS 4800)
- Steel Blue (RAL 5011)	- Slate Grey (RAL 7015)	- Window Grey (RAL 7040)	- Agate Grey (RAL 7038)
- Stone Grey (RAL 7030)	- Light grey (RAL 7035)		

Timber effect finishes are available in either a Golden Oak or Rosewood foil coat timber effect.

## Handle

Black handle as standard, optional handles are available. Doors can be supplied undrilled and without handle and locking mechanism for use with electric operator (Wentwood and Sherwood only available in the timber affect finishes). This option makes the door purpose made and will therefore increase lead-time, please specify clearly on order.

## Terminology

Nominal Door Size: This is the actual door panel size plus the fitting tolerances. The nominal door size should be used for internal dimensions of a timber frame.

Size Code: This has traditionally been used to order doors. This may not be the actual door size.

## Stock availability

Prices in bold show stock doors in Traffic White (unless specified) and all other prices relate to non-stock doors.

## Packaging

All doors are supplied unwrapped as standard, with optional poly-wrapping available.

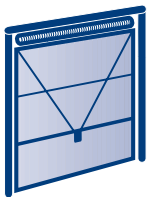

### Canopy gearing (shown as C)

Canopy gear is available for all single doors providing a reliable and affordable gearing solution, with no tracks running back into the garage.

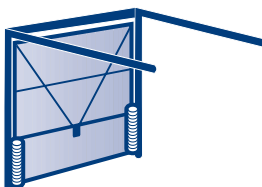

### Retractable gearing (shown as R)

Retractable gear is available for all single and double doors providing a reliable and affordable gearing solution, with tracks running back into the garage.

Single door

Nominal Door Size  
Width x Height  
(mm x mm)

Size  
Code

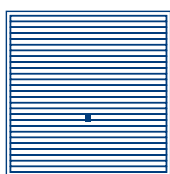

Horizon

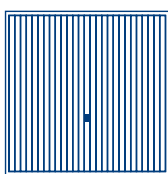

Carlton

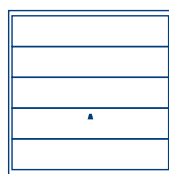

Ascot

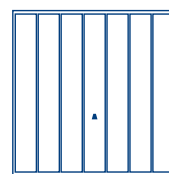

Windsor

Nominal Door Size Width x Height (mm x mm)	Size Code	Horizon		Carlton		Ascot		Windsor	
		C	R	C	R	C	R	C	R
1984 x 1830	6660	908	957	1028	1077	-	-	-	-
1984 x 1905	6663	908	957	1028	1077	-	-	-	-
1984 x 1931	6664	<b>908</b>	<b>957</b>	1028	1077	-	-	-	-
1984 x 1981	6666	<b>860</b>	<b>909</b>	977	1026	-	-	-	-
1984 x 2136	6670	860	909	977	1026	976	1025	-	-
2084 x 1931	61064	<b>876</b>	<b>925</b>	976	1025	-	-	-	-
2084 x 1981	61066	<b>901</b>	<b>950</b>	<b>976</b>	<b>1025</b>	1027	1076	-	-
2084 x 2136	61070	<b>933</b>	<b>982</b>	<b>998</b>	<b>1047</b>	1049	1098	-	-
2134 x 1830	7060	<b>934</b>	<b>983</b>	1056	1105	-	-	-	-
2134 x 1905	7063	<b>887</b>	<b>936</b>	<b>983</b>	<b>1032</b>	-	-	-	-
2134 x 1931	7064	<b>887</b>	<b>936</b>	<b>983</b>	<b>1032</b>	-	-	-	-
2134 x 1981	7066	<b>822</b> <sup>1</sup>	<b>871</b> <sup>1</sup>	<b>950</b> <sup>1</sup>	<b>999</b> <sup>1</sup>	<b>1002</b> <sup>1</sup>	<b>1051</b> <sup>1</sup>	<b>1171</b>	<b>1220</b>
2134 x 2036	7068	938	987	1039	1088	-	-	1189	1238
2134 x 2136	7070	<b>902</b> <sup>1</sup>	<b>951</b> <sup>1</sup>	<b>990</b> <sup>1</sup>	<b>1039</b> <sup>1</sup>	<b>1118</b> <sup>1</sup>	<b>1167</b> <sup>1</sup>	<b>1208</b>	<b>1257</b>
2134 x 2186	7072	973	1022	1063	1112	-	-	1281	1330
2134 x 2286	7076	-	1145	-	1228	-	-	-	-
2170 x 1905	7163	887	936	983	1032	-	-	-	-
2170 x 1931	7164	<b>887</b>	<b>936</b>	983	1032	-	-	-	-
2170 x 1981	7166	<b>822</b>	<b>871</b>	<b>950</b>	<b>999</b>	1002	1051	1171	1220
2170 x 2036	7168	938	987	1039	1088	-	-	-	-
2170 x 2136	7170	<b>902</b>	<b>951</b>	<b>990</b>	<b>1039</b>	1118	1167	1208	1257
2170 x 2186	7172	973	1022	1063	1112	-	-	-	-
2170 x 2286	7176	-	1266	-	1334	-	-	-	-
2224 x 1905	7363	967	1016	1027	1076	-	-	-	-
2224 x 1931	7364	<b>967</b>	<b>1016</b>	1027	1076	-	-	-	-
2224 x 1981	7366	<b>970</b>	<b>1019</b>	1032	1081	1083	1132	-	-
2224 x 2036	7368	1010	1059	1095	1144	-	-	-	-
2224 x 2136	7370	984	1033	<b>1045</b>	<b>1094</b>	1096	1145	-	-
2224 x 2186	7372	1066	1115	1129	1178	-	-	-	-
2259 x 1905	7563	957	1006	1039	1088	-	-	-	-
2259 x 1931	7564	<b>957</b>	<b>1006</b>	1039	1088	-	-	-	-
2259 x 1981	7566	<b>967</b>	<b>1016</b>	<b>1039</b>	<b>1088</b>	1146	1195	1251	1300
2259 x 2036	7568	1010	1059	1095	1144	-	-	1301	1350
2259 x 2136	7570	<b>1097</b>	<b>1146</b>	<b>1170</b>	<b>1219</b>	1301	1350	1353	1402
2259 x 2186	7572	1181	1230	1210	1259	-	-	1442	1491
2259 x 2286	7576	-	1364	-	1334	-	-	-	-
2284 x 1905	7663	967	1016	1066	1115	-	-	-	-
2284 x 1931	7664	<b>967</b>	<b>1016</b>	1066	1115	-	-	-	-
2284 x 1981	7666	<b>967</b>	<b>1016</b>	<b>1066</b>	<b>1115</b>	1146	1195	1251	1300
2284 x 2036	7668	1022	1071	1125	1174	-	-	1301	1350
2284 x 2136	7670	<b>1102</b>	<b>1151</b>	<b>1170</b> <sup>1</sup>	<b>1219</b> <sup>1</sup>	1285	1334	1353	1402
2284 x 2186	7672	1183	1232	<b>1254</b>	<b>1303</b>	-	-	1442	1491
2284 x 2286	7676	-	1368	-	1334	-	-	-	-
2439 x 1905	8063	1114	1163	1262	1311	-	-	-	-
2439 x 1931	8064	<b>1114</b>	<b>1163</b>	1262	1311	-	-	-	-
2439 x 1981	8066	<b>1114</b>	<b>1163</b>	<b>1262</b>	<b>1311</b>	1276	1325	1452	1501
2439 x 2036	8068	1176	1225	1330	1379	-	-	1472	1521
2439 x 2136	8070	<b>1139</b>	<b>1188</b>	<b>1303</b> <sup>1</sup>	<b>1352</b> <sup>1</sup>	1318 <sup>1</sup>	1367 <sup>1</sup>	1493	1542
2439 x 2186	8072	1220	1269	1399	1448	-	-	1584	1633
2439 x 2286	8076	-	1335	-	1453	-	-	-	-
2590 x 1981	8666	-	1285	-	1449	-	-	-	-
2590 x 2136	8670	-	1330	-	1507	-	-	-	-
2590 x 2286	8676	-	1467	-	1638	-	-	-	-
2744 x 1981	9066	-	1536	-	1555	-	-	-	-
2744 x 2136	9070	-	1613	-	1638	-	-	-	-
2744 x 2286	9076	-	1675	-	1699	-	-	-	-
3049 x 1981	1066	-	1810	-	1746	-	-	-	-
3049 x 2136	1070	-	1833	-	1766	-	-	-	-

Stock doors also available in Jet Black (based on RAL 9005).

<sup>1</sup> Stock doors also available in Anthracite Grey (RAL 7016)

For further options please see page 15.

Single door

Nominal Door Size  
Width x Height  
(mm x mm)

Size  
Code

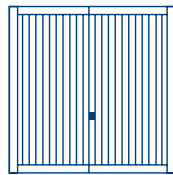

Sutton

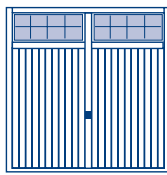

Salisbury <sup>1</sup>

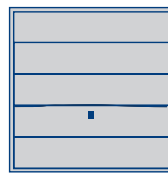

Wentwood  
Timber Effect

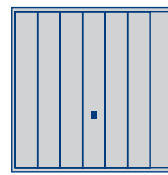

Sherwood  
Timber Effect

Nominal Door Size Width x Height (mm x mm)	Size Code	Sutton		Salisbury <sup>1</sup>		Wentwood Timber Effect		Sherwood Timber Effect	
		C	R	C	R	C	R	C	R
1984 x 1830	6660	-	-	-	-	-	-	-	-
1984 x 1905	6663	-	-	-	-	-	-	-	-
1984 x 1931	6664	-	-	-	-	-	-	-	-
1984 x 1981	6666	-	-	-	-	-	-	-	-
1984 x 2136	6670	-	-	-	-	-	-	-	-
2084 x 1931	61064	-	-	-	-	-	-	-	-
2084 x 1981	61066	-	-	-	-	-	-	-	-
2084 x 2136	61070	-	-	-	-	-	-	-	-
2134 x 1830	7060	-	-	-	-	-	-	-	-
2134 x 1905	7063	-	-	-	-	-	-	-	-
2134 x 1931	7064	1073	1122	1632	1681	-	-	-	-
2134 x 1981	7066	1016	1065	<b>1632</b>	<b>1681</b>	<b>1057</b>	<b>1106</b>	<b>1226</b>	<b>1275</b>
2134 x 2036	7068	-	-	1720	1769	-	-	-	-
2134 x 2136	7070	<b>1083</b>	<b>1132</b>	<b>1651</b>	<b>1700</b>	<b>1174</b>	<b>1223</b>	<b>1262</b>	<b>1311</b>
2134 x 2186	7072	-	-	1748	1797	-	-	-	-
2134 x 2286	7076	-	-	-	1880	-	-	-	-
2170 x 1931	7164	-	-	1632	1681	-	-	-	-
2170 x 1981	7166	-	-	1632	1681	-	-	-	-
2170 x 2036	7168	-	-	1720	1769	-	-	-	-
2170 x 2136	7170	-	-	1651	1700	-	-	-	-
2170 x 2186	7172	-	-	1748	1797	-	-	-	-
2170 x 2286	7176	-	-	-	1880	-	-	-	-
2224 x 1931	7364	-	-	1697	1746	-	-	-	-
2224 x 1981	7366	-	-	1697	1746	-	-	-	-
2224 x 2136	7370	-	-	1713	1762	-	-	-	-
2224 x 2186	7372	-	-	1809	1858	-	-	-	-
2259 x 1931	7564	1177	1226	1697	1746	-	-	-	-
2259 x 1981	7566	1177	1226	1697	1746	-	-	-	-
2259 x 2036	7568	-	-	1785	1834	-	-	-	-
2259 x 2136	7570	1296	1345	1713	1762	-	-	-	-
2259 x 2186	7572	-	-	1811	1860	-	-	-	-
2259 x 2286	7576	-	-	-	1942	-	-	-	-
2284 x 1931	7664	1190	1239	1697	1746	-	-	-	-
2284 x 1981	7666	1130	1179	1697	1746	<b>1201</b>	<b>1250</b>	<b>1304</b>	<b>1353</b>
2284 x 2036	7668	-	-	1785	1834	-	-	-	-
2284 x 2136	7670	1248	1297	<b>1713</b> <sup>2</sup>	<b>1762</b> <sup>2</sup>	<b>1337</b>	<b>1386</b>	<b>1410</b>	<b>1459</b>
2284 x 2186	7672	-	-	1811	1860	-	-	-	-
2284 x 2286	7676	-	-	-	1942	-	-	-	-
2439 x 1931	8064	1311	1360	1802	1851	-	-	-	-
2439 x 1981	8066	1311	1360	1802	1851	<b>1329</b>	<b>1378</b>	<b>1503</b>	<b>1552</b>
2439 x 2036	8068	-	-	1891	1940	-	-	-	-
2439 x 2136	8070	1334	1383	<b>1817</b>	<b>1866</b>	<b>1377</b>	<b>1426</b>	<b>1551</b>	<b>1600</b>
2439 x 2186	8072	-	-	1915	1964	-	-	-	-
2439 x 2286	8076	-	-	-	-	-	-	-	-
2590 x 1981	8666	-	-	-	-	-	-	-	-
2590 x 2136	8670	-	-	-	-	-	-	-	-
2590 x 2286	8676	-	-	-	-	-	-	-	-
2744 x 1981	9066	-	-	-	-	-	-	-	-
2744 x 2136	9070	-	-	-	-	-	-	-	-
2744 x 2286	9076	-	-	-	-	-	-	-	-
3049 x 1981	1066	-	-	-	-	-	-	-	-
3049 x 2136	1070	-	-	-	-	-	-	-	-

<sup>1</sup> Salisbury windows (with window icon) come as white as standard, colour match windows are available to order as an option, see page 15.

<sup>2</sup> Also available on 1 week lead time in Jet Black (RAL 9005) with black colour match windows.

Please note that doors with windows may have cross bracing or locking rods passing behind the windows depending upon size and gear type.

Stock doors also available in Jet Black (based on RAL 9005).

Wentwood and Sherwood models are only available in either a Golden Oak or Rosewood foil coat timber effect finish. For further options please see page 15.



Single door

Nominal Door Size  
Width x Height  
(mm x mm)

Size  
Code

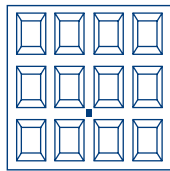

Georgian

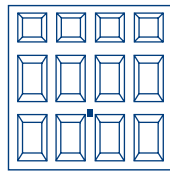

Beaumont

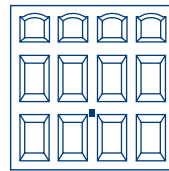

Cathedral

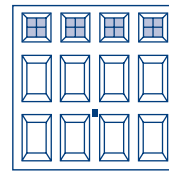

Beaumont with  
Windows<sup>1</sup>

Nominal Door Size Width x Height (mm x mm)	Size Code	Georgian		Beaumont		Cathedral		Beaumont with Windows <sup>1</sup>	
		C	R	C	R	C	R	C	R
1984 x 1830	6660	-	-	-	-	-	-	-	-
1984 x 1905	6663	-	-	-	-	-	-	-	-
1984 x 1931	6664	1257	1306	1257	1306	1257	1306	1711	1760
1984 x 1981	6666	1191	1240	1191	1240	1191	1240	1718	1767
1984 x 2136	6670	1209	1258	1209	1258	1209	1258	1662	1711
2084 x 1931	61064	1205	1254	1205	1254	1205	1254	1658	1707
2084 x 1981	61066	1207	1256	1207	1256	1207	1256	1660	1709
2084 x 2136	61070	1294	1343	1294	1343	1294	1343	1745	1794
2134 x 1830	7060	-	-	-	-	-	-	-	-
2134 x 1905	7063	-	-	-	-	-	-	-	-
2134 x 1931	7064	1207	1256	1207	1256	1207	1256	1660	1709
2134 x 1981	7066	<b>1207</b>	<b>1256</b>	<b>1207</b>	<b>1256</b>	<b>1207</b>	<b>1256</b>	<b>1660</b>	<b>1709</b>
2134 x 2136	7070	<b>1279</b>	<b>1328</b>	<b>1279</b>	<b>1328</b>	<b>1279</b>	<b>1328</b>	<b>1729</b>	<b>1778</b>
2134 x 2186	7072	-	-	-	-	-	-	-	-
2134 x 2286	7076	-	1521	-	1521	-	1521	-	1971
2170 x 1931	7164	1207	1256	1207	1256	1207	1256	1660	1709
2170 x 1981	7166	1207	1256	1207	1256	1207	1256	1660	1709
2170 x 2136	7170	1279	1328	1279	1328	1279	1328	1729	1778
2170 x 2186	7172	-	-	-	-	-	-	-	-
2170 x 2286	7176	-	1643	-	1643	-	1643	-	2097
2224 x 1931	7364	1341	1390	1341	1390	1341	1390	1797	1846
2224 x 1981	7366	1348	1397	1348	1397	1348	1397	1803	1852
2224 x 2136	7370	1356	1405	1356	1405	1356	1405	1810	1859
2224 x 2186	7372	-	-	-	-	-	-	-	-
2259 x 1931	7564	1341	1390	1341	1390	1341	1390	1797	1846
2259 x 1981	7566	1341	1390	1341	1390	1341	1390	1797	1846
2259 x 2136	7570	1542	1591	1542	1591	1542	1591	2001	2050
2259 x 2186	7572	-	-	-	-	-	-	-	-
2259 x 2286	7576	-	1873	-	1873	-	1873	-	2325
2284 x 1931	7664	1341	1390	1341	1390	1341	1390	1797	1846
2284 x 1981	7666	<b>1341</b>	<b>1390</b>	1341	1390	1341	1390	1797	1846
2284 x 2136	7670	<b>1542</b>	<b>1591</b>	<b>1542</b>	<b>1591</b>	1542	1591	<b>2001</b>	<b>2050</b>
2284 x 2286	7676	-	1873	-	1873	-	1873	-	2325
2439 x 1931	8064	1587	1636	1587	1636	1587	1636	2041	2090
2439 x 1981	8066	<b>1587</b>	<b>1636</b>	1587	1636	1587	1636	2041	2090
2439 x 2136	8070	1654	1703	1654	1703	1654	1703	2106	2155
2439 x 2186	8072	-	-	-	-	-	-	-	-
2439 x 2286	8076	-	1837	-	1837	-	1837	-	2363
2590 x 1981	8666	-	1693	-	1693	-	1693	-	2216
2590 x 2136	8670	-	1712	-	1712	-	1712	-	2239
2590 x 2286	8676	-	1897	-	1897	-	1897	-	2419
2744 x 1981	9066	-	1718	-	1718	-	1718	-	2246
2744 x 2136	9070	-	1741	-	1741	-	1741	-	2264
2744 x 2286	9076	-	1922	-	1922	-	1922	-	2450
3049 x 1981	1066	-	1782	-	1782	-	1782	-	2311
3049 x 2136	1070	-	1819	-	1819	-	1819	-	2350

<sup>1</sup> Windows for Beaumont: Standard (□), Diamond (◊), Cross (⊕). Please state on order if clear or crystal panes, see page 15.

Please note that doors with windows may have cross bracing or locking rods passing behind the windows depending upon size and gear type.

Stock doors also available in Jet Black (based on RAL 9005).

For further options please see page 15.

## Single door

Nominal Door Size  
Width x Height  
(mm x mm)

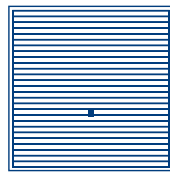

Horizon

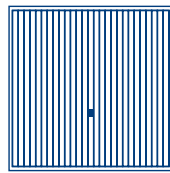

Carlton

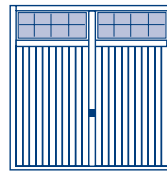

Salisbury

		C		R		C		R	
1830-1930	x 1830-1930	1197	1246	1243	1292	-	-	-	-
1830-1930	x 1931-1981	1242	1291	1288	1337	-	-	-	-
1830-1930	x 1982-2136	1335	1384	1363	1412	-	-	-	-
1830-1930	x 2137-2186	1417	1466	1445	1494	-	-	-	-
1830-1930	x 2187-2286	-	1502	-	1553	-	-	-	-
1830-1930	x 2287-2439	-	-	-	1654	-	-	-	-
1931-1984	x 1830-1930	1205	1254	1257	1306	-	-	-	-
1931-1984	x 1931-1981	1250	1299	1299	1348	-	-	-	-
1931-1984	x 1982-2136	1326	1375	1368	1417	-	-	-	-
1931-1984	x 2137-2186	1407	1456	1450	1499	-	-	-	-
1931-1984	x 2187-2286	-	1502	-	1553	-	-	-	-
1931-1984	x 2287-2439	-	1611	-	1654	-	-	-	-
1985-2134	x 1830-1930	1250	1299	1297	1346	-	-	-	-
1985-2134	x 1931-1981	1326	1375	1368	1417	-	-	-	-
1985-2134	x 1982-2136	1431	1480	1458	1507	-	-	-	-
1985-2134	x 2137-2186	1513	1562	1539	1588	-	-	-	-
1985-2134	x 2187-2286	-	1611	-	1654	-	-	-	-
1985-2134	x 2287-2439	-	1712	-	1743	-	-	-	-
2135-2284	x 1830-1930	1326	1375	1352	1401	-	-	-	-
2135-2284	x 1931-1981	1431	1480	1458	1507	-	-	-	-
2135-2284	x 1982-2136	1521	1570	1569	1618	1957	2006	-	-
2135-2284	x 2137-2186	1602	1651	1651	1700	2039	2088	-	-
2135-2284	x 2187-2286	-	1712	-	1743	-	2336	-	-
2135-2284	x 2287-2439	-	1818	-	1864	-	-	-	-
2285-2439	x 2137-2186	1613	1662	1735	1784	2243	2292	-	-
2285-2439	x 2187-2286	-	1746	-	1782	-	2290	-	-
2285-2499 <sup>1</sup>	x 1830-1930	1431	1480	1473	1522	-	-	-	-
2285-2499 <sup>1</sup>	x 1931-1981	1521	1570	1569	1618	-	-	-	-
2285-2499 <sup>1</sup>	x 1982-2136	1532	1581	1654	1703	2161	2210	-	-
2285-2499	x 2287-2439	-	1819	-	1838	-	-	-	-
2500-2590	x 1830-1930	-	1638	-	1667	-	-	-	-
2500-2590	x 1931-1981	-	1712	-	1743	-	-	-	-
2500-2590	x 1982-2136	-	1819	-	1819	-	-	-	-
2500-2590	x 2137-2286	-	1838	-	1838	-	-	-	-
2500-2590	x 2287-2439	-	1950	-	1950	-	-	-	-
2591-2722	x 1830-1930	-	1741	-	1741	-	-	-	-
2591-2722	x 1931-1981	-	1810	-	1810	-	-	-	-
2591-2722	x 1982-2136	-	1936	-	1936	-	-	-	-
2591-2722	x 2137-2286	-	2057	-	2057	-	-	-	-
2591-2722	x 2287-2439	-	2193	-	2193	-	-	-	-
2723-3049	x 1830-1930	-	-	-	2118	-	-	-	-
2723-3049	x 1931-1981	-	-	-	2192	-	-	-	-
2723-3049	x 1982-2136	-	-	-	2415	-	-	-	-

<sup>1</sup> Canopy gear only available up to 2439 wide.

Orders for purpose made sizes will only be accepted as nominal door size for unframed version and overall frame size when ordering a framed version. Orders for purpose made framed doors will not be accepted as nominal door size. For further options please see page 15.

Single door

Nominal Door Size  
Width x Height  
(mm x mm)

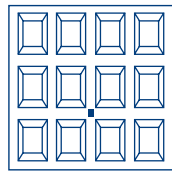

Georgian

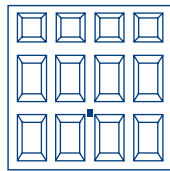

Beaumont

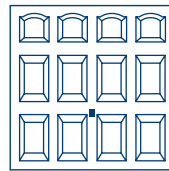

Cathedral

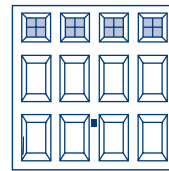

Beaumont with Windows<sup>2</sup>

		C		R		C		R		C		R	
1830-1930	x 1830-1930	-	-	-	-	-	-	-	-	-	-	-	-
1830-1930	x 1931-1981	-	-	-	-	-	-	-	-	-	-	-	-
1830-1930	x 1982-2136	-	-	-	-	-	-	-	-	-	-	-	-
1830-1930	x 2137-2186	1920	1969	1920	1969	1920	1969	2374	2423				
1830-1930	x 2187-2286	-	-	-	-	-	-	-	-	-	-	-	-
1830-1930	x 2287-2439	-	-	-	-	-	-	-	-	-	-	-	-
1931-1984	x 1830-1930	-	-	-	-	-	-	-	-	-	-	-	-
1931-1984	x 1931-1981	-	-	-	-	-	-	-	-	-	-	-	-
1931-1984	x 1982-2136	-	-	-	-	-	-	-	-	-	-	-	-
1931-1984	x 2137-2186	1920	1969	1920	1969	1920	1969	2374	2423				
1931-1984	x 2187-2286	-	-	-	-	-	-	-	-	-	-	-	-
1931-1984	x 2287-2439	-	-	-	-	-	-	-	-	-	-	-	-
1985-2134	x 1830-1930	-	-	-	-	-	-	-	-	-	-	-	-
1985-2134	x 1931-1981	1884	1933	1884	1933	1884	1933	2337	2386				
1985-2134	x 1982-2136	2002	2051	2002	2051	2002	2051	2455	2504				
1985-2134	x 2137-2186	2083	2132	2083	2132	2083	2132	2536	2585				
1985-2134	x 2187-2286	-	2199	-	2199	-	2199	-	2652				
1985-2134	x 2287-2439	-	2120	-	2120	-	2120	-	2573				
2135-2284	x 1830-1930	-	-	-	-	-	-	-	-	-	-	-	-
2135-2284	x 1931-1981	2018	2067	2018	2067	2018	2067	2474	2523				
2135-2284	x 1982-2136	2018	2067	2018	2067	2018	2067	2474	2523				
2135-2284	x 2137-2186	2100	2149	2100	2149	2100	2149	2555	2604				
2135-2284	x 2187-2286	-	2178	-	2178	-	2178	-	2634				
2135-2284	x 2287-2439	-	2480	-	2480	-	2480	-	2933				
2285-2439	x 2137-2186	2327	2376	2327	2376	2327	2376	2821	2870				
2285-2439	x 2187-2286	-	2317	-	2317	-	2317	-	2771				
2285-2499 <sup>1</sup>	x 1830-1930	-	-	-	-	-	-	-	-	-	-	-	-
2285-2499 <sup>1</sup>	x 1931-1981	2141	2190	2141	2190	2141	2190	2598	2647				
2285-2499 <sup>1</sup>	x 1982-2136	2177	2226	2177	2226	2177	2226	2633	2682				
2285-2439	x 2187-2286	-	2317	-	2317	-	2317	-	2771				
2285-2499	x 2287-2439	-	2411	-	2411	-	2411	-	2864				
2500-2590	x 1830-1930	-	-	-	-	-	-	-	-	-	-	-	-
2500-2590	x 1931-1981	-	2297	-	2297	-	2297	-	2752				
2500-2590	x 1982-2136	-	2333	-	2333	-	2333	-	2790				
2500-2590	x 2137-2286	-	2387	-	2387	-	2387	-	2842				
2500-2590	x 2287-2439	-	2465	-	2465	-	2465	-	2915				
2591-2722	x 1830-1930	-	-	-	-	-	-	-	-	-	-	-	-
2591-2722	x 1931-1981	-	2307	-	2307	-	2307	-	2761				
2591-2722	x 1982-2136	-	2416	-	2416	-	2416	-	2874				
2591-2722	x 2137-2286	-	2489	-	2489	-	2489	-	2945				
2591-2722	x 2287-2439	-	-	-	-	-	-	-	-	-	-	-	-
2723-3049	x 1830-1930	-	-	-	-	-	-	-	-	-	-	-	-
2723-3049	x 1931-1981	-	2465	-	2465	-	2465	-	2915				
2723-3049	x 1982-2136	-	2557	-	2557	-	2557	-	3010				

<sup>1</sup> Canopy gear only available up to 2439 wide.

<sup>2</sup> Windows for Beaumont: Standard (□), Diamond (◊), Cross (⊕). Please state on order if clear or crystal panes.

Orders for purpose made sizes will only be accepted as nominal door size for unframed version and overall frame size when ordering a framed version. Orders for purpose made framed doors will not be accepted as nominal door size.

Please note that doors with windows may have cross bracing or locking rods passing behind the windows depending upon size and gear type. For further options please see page 15.

Double door

Nominal Door Size  
Width x Height  
(mm x mm)

Size  
Code

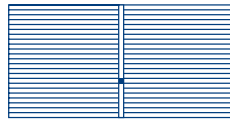

Horizon

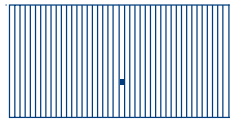

Carlton

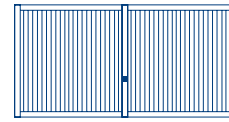

Sutton

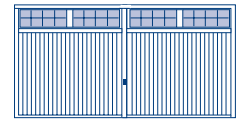

Salisbury

		R	R	R	R
3049 x 2286	1076	2344	2344	-	-
3354 x 1981	1166	2192	2192	-	-
3354 x 2136	1170	2209	2209	-	-
3354 x 2286	1176	2265	2265	-	-
3659 x 1981	1266	2302	2302	-	-
3659 x 2136	1270	2319	2319	-	-
3659 x 2286	1276	2483	2483	-	-
3964 x 1981	1366	2504	2504	-	-
3964 x 2136	1370	2523	2523	-	-
3964 x 2286	1376	2764	2764	-	-
4269 x 1981	1466	<b>2413</b>	<b>2413</b>	2609	3340
4268 x 2036	1468	2413	2413	-	-
4269 x 2136	1470	<b>2413</b>	<b>2413</b>	2609	<b>3240</b>
4268 x 2186	1472	2413	2413	-	<b>3340</b>
4267 x 2186	1476	2413	2413	-	<b>3240</b>
4574 x 1981	1566	2598	2598	2795	-
4574 x 2136	1570	2636	2636	2833	-
4879 x 1981	1666	2748	2748	2944	-
4879 x 2136	1670	2783	2783	2979	-

Double door

Nominal Door Size  
Width x Height  
(mm x mm)

Size  
Code

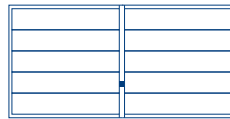

Ascot

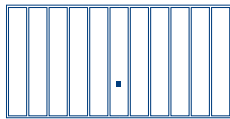



Windsor

		R	R
3049 x 2286	1076	-	-
3354 x 1981	1166	-	-
3354 x 2136	1170	-	-
3354 x 2286	1176	-	-
3659 x 1981	1266	-	-
3659 x 2136	1270	-	-
3659 x 2286	1276	-	-
3964 x 1981	1366	-	-
3964 x 2136	1370	-	-
3964 x 2286	1376	-	-
4269 x 1981	1466	2551	2551
4269 x 2136	1470	2551	2551
4574 x 1981	1566	-	-
4574 x 2136	1570	-	-
4879 x 1981	1666	-	-
4879 x 2136	1670	-	-

Please note that doors with windows may have cross bracing or locking rods passing behind the windows depending upon size and gear type.

For further options please see page 15.

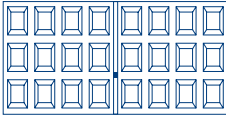
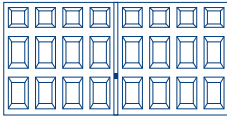
Double door

Nominal Door Size Width x Height (mm x mm)	Size Code				
		Georgian	Beaumont	Cathedral	Beaumont with Windows <sup>1</sup>
		R	R	R	R
3049 x 2286	1076	2344	2344	2344	3019
3354 x 1981	1166	2302	2302	2302	2985
3354 x 2136	1170	2302	2302	2302	2985
3354 x 2286	1176	2487	2487	2487	3169
3659 x 1981	1266	2451	2451	2451	3132
3659 x 2136	1270	2451	2451	2451	3132
3659 x 2286	1276	2563	2563	2563	3243
3964 x 1981	1366	2524	2524	2524	3205
3964 x 2136	1370	2524	2524	2524	3205
3964 x 2286	1376	2563	2563	2563	3257
4269 x 1981	1466	2598	2598	2598	3277
4269 x 2136	1470	<b>2598</b>	<b>2598</b>	<b>2598</b>	3277
4574 x 1981	1566	2822	2822	2822	3500
4574 x 2136	1570	2822	2822	2822	3500
4879 x 1981	1666	2968	2968	2968	3652
4879 x 2136	1670	2968	2968	2968	3652

<sup>1</sup> Windows for Beaumont: Standard () , Diamond () , Cross () . Please state on order if clear or crystal panes.

Please note that doors with windows may have cross bracing or locking rods passing behind the windows depending upon size and gear type.

For further options please see page 15.

### Double door

Nominal Door Size  
Width x Height  
(mm x mm)

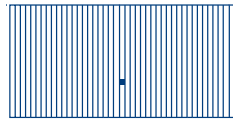

Carlton

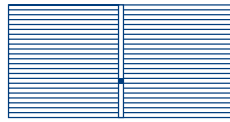

Horizon

	R	R
2745-3049 x 2137-2286	2709	-
3050-3354 x 1886-1981	2563	2598
3050-3354 x 1982-2136	2582	2617
3050-3354 x 2137-2286	2822	2858
3355-3659 x 1886-1981	2636	2672
3355-3659 x 1982-2136	2691	2727
3355-3659 x 2137-2286	2822	2858
3660-3967 x 1886-1981	2876	2913
3660-3967 x 1982-2136	2931	2968
3660-3967 x 2137-2286	3137	3171
3968-4269 x 1886-1981	2783	2822
3968-4269 x 1982-2136	2822	2858
4270-5000 x 1886-1981	3082	3115
4270-5000 x 1982-2136	3154	3191

### Double door

Nominal Door Size  
Width x Height  
(mm x mm)

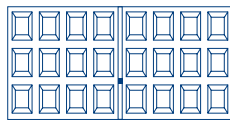

Georgian

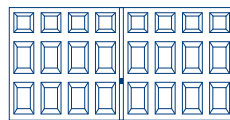

Beaumont

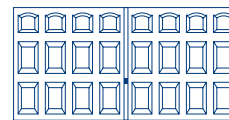

Cathedral

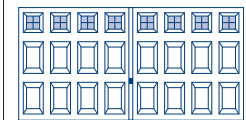

Beaumont with Windows <sup>1</sup>

	R	R	R	R
2745-3049 x 2137-2286	2709	2709	2709	3176
3050-3354 x 1931-1981	2672	2672	2672	3355
3050-3354 x 1982-2136	2709	2709	2709	3392
3050-3354 x 2137-2286	2858	2858	2858	3543
3355-3659 x 1931-1981	2822	2822	2822	3500
3355-3659 x 1982-2136	2895	2895	2895	3577
3355-3659 x 2137-2286	2931	2931	2931	3614
3660-3967 x 1931-1981	2895	2895	2895	3799
3660-3967 x 1982-2136	2931	2931	2931	3838
3660-3967 x 2137-2286	2968	2968	2968	3876
3968-4269 x 1931-1981	2968	2968	2968	3876
3968-4269 x 1982-2136	2968	2968	2968	3876
4270-5000 x 1931-1981	3340	3340	3340	4473
4270-5000 x 1982-2136	3340	3340	3340	4473

<sup>1</sup> Windows for Beaumont: Standard (□), Diamond (◊), Cross (⊠). Please state on order if clear or crystal panes.

Orders for purpose made sizes will only be accepted as nominal door size for unframed version and overall frame size when ordering a framed version. Orders for purpose made framed doors will not be accepted as nominal door size.

Please note that doors with windows may have cross bracing or locking rods passing behind the windows depending upon size and gear type. For further options please see page 15.

Options	Single doors	Double doors
	add	add
Factory pre-framed standard single doors	184	-
Steel frame for standard double doors	-	276
Factory pre-framed purpose-made single doors (framed retractable purpose made doors require a 4 week lead-time)	208	-
Steel frame for purpose made double doors	-	306
Additional Lock Kit, C-type/ R-type (fitted onto door)	86	-
Retractable plus gear available on 1931, 1981 and 2136 mm high doors up to 2744 mm wide	88	-
For powder-coated doors <sup>1</sup> : Moss Green (RAL 6005), Ruby Red (RAL 3003), Signal Blue (RAL 5005), Jet Black (RAL 9005), Steel Blue (RAL 5011), Light Ivory (RAL 1015), Pigeon Blue (RAL 5014), Fir Green (RAL 6009), Anthracite Grey (RAL 7016), Stone Grey (RAL 7030), Light Grey (RAL 7035), Slate Grey (RAL 7015), Agate Grey (RAL 7038), Window Grey (RAL 7040), Chartwell Green (BS 4800), Burgundy Brown <sup>2</sup> , Golden Brown <sup>2</sup> and Terra Brown (RAL 8028).	182	284
Coloured window frames to match door colour – Beaumont doors (price per window). Beaumont doors up to 3049 wide = 4 windows, between 3050 to 3964 = 6 windows, between 3965 to 4860 = 8 windows and over 4860 = 10 windows <sup>2</sup> .	67 each	67 each
Coloured window frames to match door colour – Salisbury doors (price per door) <sup>2</sup>	228	448
Black window panes for Salisbury doors (price per door)	52	97
Poly-wrapping	49	89
Diecast metal handles: brass effect, chrome effect, brushed steel and white	101	101
Bottom weatherseal, 2405 mm length (suitable for gaps up to 15 mm between the door and the floor level)	63	63
Bottom weatherseal, 3000 mm length (suitable for gaps up to 15 mm between the door and the floor level)	70	70
Surcharge on White RAL 9016 doors for colour steel frame in RAL colour not matching Garage door	182	284

<sup>1</sup> Please state coloured windows required on order. Coloured Beaumont with windows and Salisbury doors are supplied with white window frames as standard.

<sup>2</sup> Colour match windows not available in Burgundy Brown or Golden Brown.

Please note that doors with windows may have cross bracing or locking rods passing behind the windows depending upon size and gear type.

# Guardian Range

## Secured By Design certified Up & Over doors

These doors have been tested to the STS 202 Security Technical Specification and achieve Secured By Design accreditation. Lock body protection, anti-snap cylinder, high security bracing and improved lock security make these doors even more secure.

## Information

Guardian Range doors come with a pre-fitted steel frame and cannot be fitted to a custom made timber frame.

Guardian Range doors are not suitable for automation. Only available with canopy or retractable lifting gear.

Retractable plus not available.

Window panes on Secured by Design Salisbury doors are black non-translucent.

## Single door - standard sizes

Nominal Door Size  
Width x Height  
(mm x mm)

Size  
Code

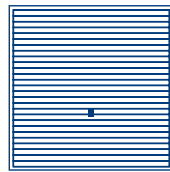

Horizon

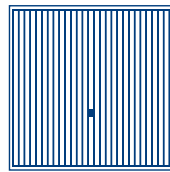

Carlton

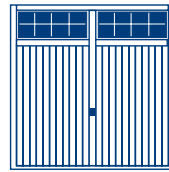

Salisbury

Nominal Door Size Width x Height (mm x mm)	Size Code	Horizon		Carlton		Salisbury	
		C	R	C	R	C	R
1984 x 1830	6660	1528	1577	1655	1704	-	-
1984 x 1905	6663	1528	1577	1655	1704	-	-
1984 x 1931	6664	1528	1577	1655	1704	-	-
1984 x 1981	6666	1486	1535	1604	1653	-	-
1984 x 2136	6670	1502	1551	1604	1653	-	-
2084 x 1931	61064	1502	1551	1604	1653	-	-
2084 x 1981	61066	1523	1572	1604	1653	-	-
2084 x 2136	61070	1555	1604	1621	1670	-	-
2134 x 1830	7060	1557	1606	1679	1728	-	-
2134 x 1905	7063	1509	1558	1607	1656	-	-
2134 x 1931	7064	1509	1558	1607	1656	2259	2308
2134 x 1981	7066	1410	1459	1574	1623	2259	2308
2134 x 2031	7068	1596	1645	1697	1746	-	-
2134 x 2136	7070	1524	1573	1615	1664	2276	2325
2134 x 2186	7072	-	1679	-	1777	-	-
2170 x 1931	7164	1596	1645	1674	1723	-	-
2170 x 1981	7166	1410	1459	1574	1623	-	-
2170 x 2036	7168	1596	1645	1697	1746	-	-
2170 x 2136	7170	1621	1670	1726	1775	-	-
2170 x 2186	7172	-	1692	-	1796	-	-
2224 x 1931	7364	1588	1637	1654	1703	-	-
2224 x 1981	7366	1596	1645	1658	1707	-	-
2224 x 2136	7370	1610	1659	1670	1719	-	-
2259 x 1931	7564	1639	1688	1708	1757	2320	2369
2259 x 1981	7566	1588	1637	1662	1711	2320	2369
2259 x 2036	7568	1724	1773	1794	1843	-	-
2259 x 2136	7570	1724	1773	1794	1843	2337	2386
2259 x 2286	7572	-	1794	-	1865	-	-
2284 x 1931	7664	1588	1637	1692	1741	2320	2369
2284 x 1981	7666	1588	1637	1692	1741	2320	2369
2284 x 2031	7668	1678	1727	1787	1836	-	-
2284 x 2136	7670	1726	1775	1794	1843	2337	2386
2284 x 2186	7672	-	-	-	1965	-	-
2439 x 1931	8064	-	-	-	1959	-	2496
2439 x 1981	8066	-	-	-	1959	-	2496
2439 x 2031	8068	-	-	-	2069	-	-
2439 x 2136	8070	-	-	-	2002	-	2517
2439 x 2186	8072	-	-	-	2114	-	-
2590 x 1981	8666	-	-	-	2071	-	-
2590 x 2136	8670	-	-	-	2132	-	-
2744 x 1981	9066	-	-	-	2175	-	-
2744 x 2136	9070	-	-	-	2260	-	-

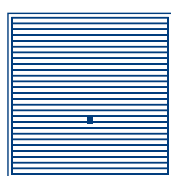

**Single door -  
purpose-made sizes**Nominal Door Size  
Width x Height  
(mm x mm)

Horizon

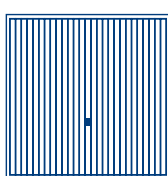

Carlton

		Horizon		Carlton	
		C	R	C	R
1985-2134	x 1830-1930	1874	1923	1920	1969
1985-2134	x 1931-1981	1948	1997	1999	2048
1985-2134	x 1982-2136	2057	2106	2083	2132
2135-2284	x 1830-1930	1948	1997	1977	2026
2135-2284	x 1931-1981	2057	2106	2057	2106
2135-2284	x 1982-2136	2142	2191	2191	2240
2285-2499	x 1830-1930	-	-	-	2136
2285-2499	x 1931-1981	-	-	-	2223
2285-2499	x 1982-2136	-	-	-	2306
2500-2590	x 1830-1930	-	-	-	2250
2500-2590	x 1931-1981	-	-	-	2319
2500-2590	x 1982-2136	-	-	-	2397
2591-2722	x 1830-1930	-	-	-	2317
2591-2722	x 1931-1981	-	-	-	2385
2591-2722	x 1982-2136	-	-	-	2508

Orders for purpose made sizes will only be accepted as overall frame size when ordering a framed version. Orders for purpose made framed doors will not be accepted as nominal door size.

**Options for single doors**

add

For powder coated doors: Moss Green (RAL 6005), Ruby Red (RAL 3003), Signal Blue (RAL 5005), Jet Black (RAL 9005), Steel Blue (RAL 5011), Light Ivory (RAL 1015), Pigeon Blue (RAL 5014), Fir Green (RAL 6009), Anthracite Grey (RAL 7016), Stone Grey (RAL 7030), Light Grey (RAL 7035), Slate Grey (RAL 7015), Agate Grey (RAL 7038), Window Grey (RAL 7040), Chartwell Green (BS 4800), Burgundy Brown<sup>2</sup>, Golden Brown<sup>2</sup> and Terra Brown (RAL 8028).

182

Coloured window frames on Salisbury to match door colour<sup>1</sup>

228

Poly-wrapping

49

<sup>1</sup> Colour match windows not available in Burgundy Brown or Golden Brown.



Secured by Design is an association focusing on the design of more secure homes and commercial properties.

Secured by Design is owned by the ACPO (Association of Chief Police Officers) and awards the Secured by Design status to products that pass their extensive testing procedures.

# Design Range

## Surface and finish

The Series 100 Design Range skins are built from four horizontal skins, whilst the Series 200 range is constructed from three vertical skins. Stainless steel elements on Garador design range doors are manufactured from high grade 2 mm thick steel with a brushed finish. The series 100 and 200 design range doors are also available without stainless steel elements. On Design Range doors a choice of any standard colour comes free of charge, please see page 19 for a choice of the 19 standard RAL colours available.

Please note: panel doors are produced with appearance in mind. This may result in some small gaps which could allow water ingress especially in exposed locations.

## Handle

A new perfectly matched handle offers a quality feel everytime you open the door.

## Terminology

**Nominal Door Size:** This is the actual door panel size plus the fitting tolerances. The nominal door size should be used for internal dimensions of a timber frame.

**Size Code:** This has traditionally been used to order doors. This may not be the actual door size.

### Single door

Nominal Door Size  
Width x Height  
(mm x mm)

Size  
Code

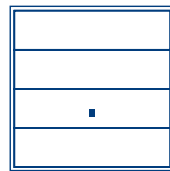

100

C

R

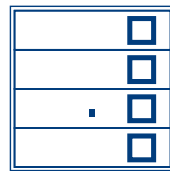

101

C

R

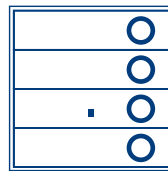

102

C

R

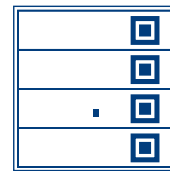

103

C

R

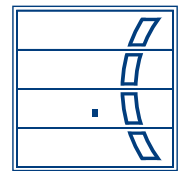

104

C

R

Nominal Door Size Width x Height (mm x mm)	Size Code	100		101		102		103		104	
		C	R	C	R	C	R	C	R	C	R
2134 x 1981	7066	1396	1445	1673	1722	1673	1722	1673	1722	1673	1722
2134 x 2136	7070	1488	1537	1765	1814	1765	1814	1765	1814	1765	1814
2259 x 1981	7566	1536	1585	1811	1860	1811	1860	1811	1860	1811	1860
2259 x 2136	7570	1626	1675	1906	1955	1906	1955	1906	1955	1906	1955
2284 x 1981	7666	1564	1613	1838	1887	1838	1887	1838	1887	1838	1887
2284 x 2136	7670	1655	1704	1932	1981	1932	1981	1932	1981	1932	1981
2439 x 1981	8066	1765	1814	2041	2090	2041	2090	2041	2090	2041	2090
2439 x 2136	8070	1857	1906	2135	2184	2135	2184	2135	2184	2135	2184

### Single door

Nominal Door Size  
Width x Height  
(mm x mm)

Size  
Code

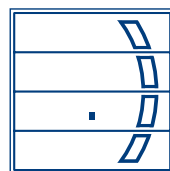

105

C

R



106

C

R

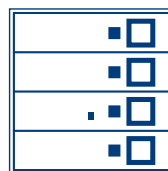

108

C

R

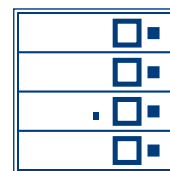

109

C

R

Nominal Door Size Width x Height (mm x mm)	Size Code	105		106		108		109	
		C	R	C	R	C	R	C	R
2134 x 1981	7066	1673	1722	1673	1722	1673	1722	1673	1722
2134 x 2136	7070	1765	1814	1765	1814	1765	1814	1765	1814
2259 x 1981	7566	1811	1860	1811	1860	1811	1860	1811	1860
2259 x 2136	7570	1906	1955	1906	1955	1906	1955	1906	1955
2284 x 1981	7666	1838	1887	1838	1887	1838	1887	1838	1887
2284 x 2136	7670	1932	1981	1932	1981	1932	1981	1932	1981
2439 x 1981	8066	2041	2090	2041	2090	2041	2090	2041	2090
2439 x 2136	8070	2135	2184	2135	2184	2135	2184	2135	2184

Single door

Nominal Door Size Width x Height (mm x mm) Size Code

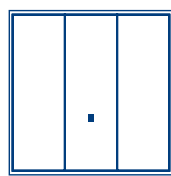

200

C R

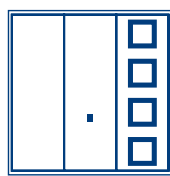

201

C R

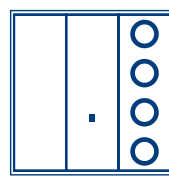

202

C R

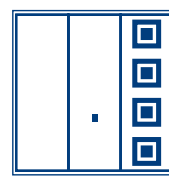

203

C R

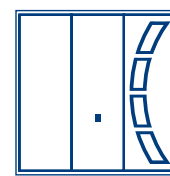

204

C R

Nominal Door Size	Size Code	200 C	200 R	201 C	201 R	202 C	202 R	203 C	203 R	204 C	204 R
2134 x 1981	7066	1396	1445	1673	1722	1673	1722	1673	1722	1673	1722
2134 x 2136	7070	1488	1537	1765	1814	1765	1814	1765	1814	1765	1814
2259 x 1981	7566	1536	1585	1811	1860	1811	1860	1811	1860	1811	1860
2259 x 2136	7570	1626	1675	1906	1955	1906	1955	1906	1955	1906	1955
2284 x 1981	7666	1564	1613	1838	1887	1838	1887	1838	1887	1838	1887
2284 x 2136	7670	1655	1704	1932	1981	1932	1981	1932	1981	1932	1981
2439 x 1981	8066	1765	1814	2041	2090	2041	2090	2041	2090	2041	2090
2439 x 2136	8070	1857	1906	2135	2184	2135	2184	2135	2184	2135	2184

Single door

Nominal Door Size Width x Height (mm x mm) Size Code

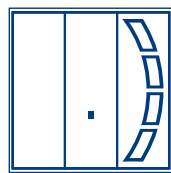

205

C R

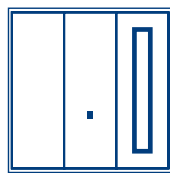

210

C R

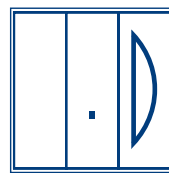

211

C R

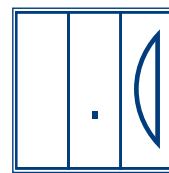

212

C R

Nominal Door Size	Size Code	205 C	205 R	210 C	210 R	211 C	211 R	212 C	212 R
2134 x 1981	7066	1673	1722	1673	1722	1673	1722	1673	1722
2134 x 2136	7070	1765	1814	1765	1814	1765	1814	1765	1814
2259 x 1981	7566	1811	1860	1811	1860	1811	1860	1811	1860
2259 x 2136	7570	1906	1955	1906	1955	1906	1955	1906	1955
2284 x 1981	7666	1838	1887	1838	1887	1838	1887	1838	1887
2284 x 2136	7670	1932	1981	1932	1981	1932	1981	1932	1981
2439 x 1981	8066	2041	2090	2041	2090	2041	2090	2041	2090
2439 x 2136	8070	2135	2184	2135	2184	2135	2184	2135	2184

Options for single doors

add

Factory pre-fitted steel frame

184

Additional Lock Kit, C-type/ R-type (fitted onto door)

86

Retractable plus gear

88

Poly-wrapping

49

Please specify on order if you would like the design elements on the right or the left hand side of the door panel (viewed from outside).

Colour options on Design Range doors are free of charge. Available options are: White (RAL 9016), Terra Brown (RAL 8028), Moss Green (RAL 6005), Ruby Red (RAL 3003), Signal Blue (RAL 5005), Jet Black (RAL 9005), Steel Blue (RAL 5011), Light Ivory (RAL 1015), Pigeon Blue (RAL 5014), Fir Green (RAL 6009), Anthracite Grey (RAL 7016), Stone Grey (RAL 7030), Light Grey (RAL 7035), Slate Grey (RAL 7015), Agate Grey (RAL 7038), Window Grey (RAL 7040), Chartwell Green (BS 4800), Burgundy Brown and Golden Brown (solid).

# GRP Premier Panel Doors

## Surface

High gloss or woodgrain finish depending on door style.

GRP Premier doors are constructed as an infill panel and are fixed into a rigid box section chassis.

The infill has a flow coat to the inside face for a smoother finish and reduced translucency.

Please note: panel doors are produced with appearance in mind. This may result in some small gaps which could allow water ingress especially in exposed locations.

## Standard colours

Arden and Stamford are available in Gloss White and Gloss Magnolia finish only. All other doors are available in the following range of woodgrain colours: White, Magnolia, Bleached Oak, Red Mahogany, Dark Mahogany, Light Oak, Dark Oak, Irish Oak, Honey Beech, Teak, Golden Brown, Ebony and Anthracite Grey.

Due to the production processes door colours may vary. Should you require matching doors please specify on your order.

Please note when trying to colour match garage doors with other UPVC products always check a colour sample first. The gel coats used in the process will not necessarily be a match and we will not guarantee a match with any other product.

## Premium colours

Our GRP premium colour range includes Blue and Green. There is an additional surcharge for these colours, see page 24 for details.

## Chassis colour

Traffic White (RAL 9016) for White Woodgrain and Gloss White doors, Black (RAL 9005) for Ebony coloured doors, Anthracite Grey (RAL 7016) for Anthracite Grey doors, Light Ivory (RAL 1015) for Magnolia Gloss and Magnolia doors, Fir Green (RAL 6009) for Green doors and Steel Blue (RAL 5011) for Blue doors.

Burgundy Brown will be used as the chassis colour for Red Mahogany, Dark Oak and Dark Mahogany.

All other doors will be supplied with a Terra Brown (RAL 8028) chassis.

## Handle

Black handle and base plate as standard, optional handles available. Doors can be supplied undrilled and without handle and locking mechanism for use with electric operator. This must be requested at the time of order.

Certain panel configurations may only be available without handle or locking, therefore only suitable for electric operation (consult Garador sales office for exact details).

## Terminology

Nominal Door Size: This is the actual door panel size plus the fitting tolerances. The nominal door size should be used for internal dimensions of a timber frame.

Size Code: This has traditionally been used to order doors. This may not be the actual door size.

## Packaging

Supplied with front surface protection as standard.

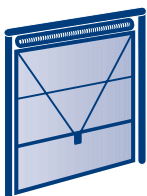

### Canopy gearing (shown as C)

Canopy gear is available for all single doors providing a reliable and affordable gearing solution, with no tracks running back into the garage.

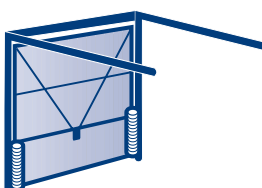

### Retractable gearing (shown as R)

Retractable gear is available for all single and double doors providing a reliable and affordable gearing solution, with tracks running back into the garage.

### Single door

Nominal Door Size  
Width x Height  
(mm x mm)

Size  
Code

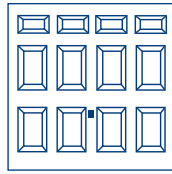

Arden

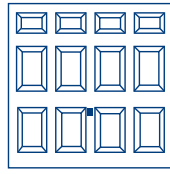

Kenmore

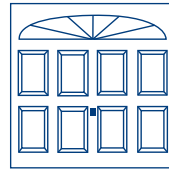

Stamford

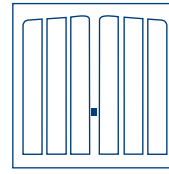

Penshurst

Nominal Door Size Width x Height (mm x mm)	Size Code	Arden		Kenmore		Stamford		Penshurst	
		C	R	C	R	C	R	C	R
2134 x 1981	7066	2794	2843	2851	2900	2933	2982	3024	3073
2134 x 2136	7070	2794	2843	2851	2900	2933	2982	3024	3073
2259 x 1981	7566	2923	2972	2998	3047	3050	3099	3258	3307
2259 x 2136	7570	2923	2972	2998	3047	3050	3099	3258	3307
2284 x 1981	7666	2945	2994	3024	3073	3084	3133	3289	3338
2284 x 2136	7670	2945	2994	3024	3073	3084	3133	3289	3338
2439 x 1981	8066	3217	3266	3251	3300	3339	3388	3500	3549
2439 x 2136	8070	3217	3266	3251	3300	3339	3388	3500	3549
2744 x 1981	9066	-	3585 <sup>1</sup>	-	3670 <sup>1</sup>	-	-	-	-
2744 x 2136	9070	-	3585 <sup>1</sup>	-	3670 <sup>1</sup>	-	-	-	-
3049 x 1981	1066	-	3935 <sup>1</sup>	-	4061 <sup>1</sup>	-	-	-	-
3049 x 2136	1070	-	3935 <sup>1</sup>	-	4061 <sup>1</sup>	-	-	-	-

<sup>1</sup> Doors only available with electric operation (Handle and Locking not available).

### Single door

Nominal Door Size  
Width x Height  
(mm x mm)

Size  
Code

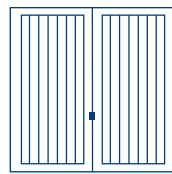

Swinton

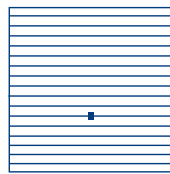

Glastonbury

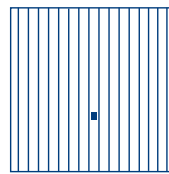

Somerset

Nominal Door Size Width x Height (mm x mm)	Size Code	Swinton		Glastonbury		Somerset	
		C	R	C	R	C	R
2134 x 1981	7066	3024	3073	3024	3073	3024	3073
2134 x 2136	7070	3024	3073	3024	3073	3024	3073
2259 x 1981	7566	3258	3307	3258	3307	3258	3307
2259 x 2136	7570	3258	3307	3258	3307	3258	3307
2284 x 1981	7666	3289	3338	3289	3338	3289	3338
2284 x 2136	7670	3289	3338	3289	3338	3289	3338
2439 x 1981	8066	3500	3549	-	-	3500	3549
2439 x 2136	8070	3500	3549	-	-	3500	3549
2744 x 1981	9066	-	-	-	-	-	3922
2744 x 2136	9070	-	-	-	-	-	3922
3049 x 1981	1066	-	-	-	-	-	4306
3049 x 2136	1070	-	-	-	-	-	4306

Please note that doors with windows may have cross bracing or locking rods passing behind the windows depending upon size and gear type.

For further options please see page 24.

### Single door

Nominal Door Size  
Width x Height  
(mm x mm)

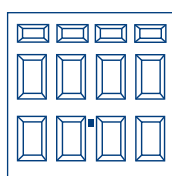

Arden  
C R

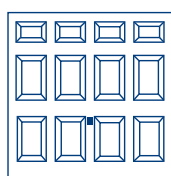

Kenmore  
C R

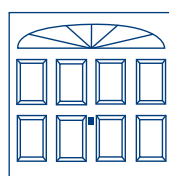

Stamford  
C R

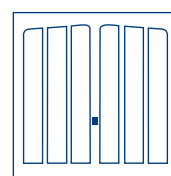

Penshurst  
C R

2032-2133	x	1931-1980	-	-	-	-	-	-	3339	3388
2032-2133	x	1981-2136	-	-	-	-	-	-	3339	3388
2032-2133	x	2137-2286	-	-	-	-	-	-	-	3857
2134-2439	x	1931-1980	-	-	-	-	-	-	3832	3881
2134-2439	x	1981-2136	3523	3572	3563	3612	3664	3713	3832	3881
2134-2439	x	2137-2286	-	4063	-	4112	-	-	-	4433
2440-2590	x	1931-1980	-	-	-	-	-	-	-	-
2440-2590	x	1981-2136	-	-	-	-	-	-	-	-
2440-2590	x	2137-2286	-	-	-	-	-	-	-	-
2591-2744	x	1931-1980	-	-	-	-	-	-	-	-
2591-2744	x	1981-2136	-	-	-	4103 <sup>1</sup>	-	-	-	-
2591-2744	x	2137-2286	-	-	-	-	-	-	-	-
2745-2896	x	1931-1980	-	-	-	-	-	-	-	-
2745-2896	x	1981-2136	-	4366 <sup>1</sup>	-	4484 <sup>1</sup>	-	-	-	-
2745-2896	x	2137-2286	-	-	-	-	-	-	-	-
2897-3049	x	1931-1980	-	-	-	-	-	-	-	-
2897-3049	x	1981-2136	-	4366 <sup>1</sup>	-	4484 <sup>1</sup>	-	-	-	-
2897-3049	x	2137-2286	-	-	-	-	-	-	-	-

<sup>1</sup> Doors only available with electric operation (Handle and Locking not available).

### Single door

Nominal Door Size  
Width x Height  
(mm x mm)

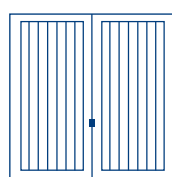

Swinton  
C R

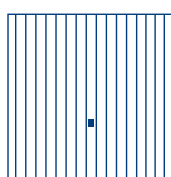

Somerset  
C R

2259-2439	x	1981-2136	3832	3881	3832	3883
2259-2439	x	2150-2286	-	4148	-	3889
2440-2590	x	1931-1980	-	-	-	3946
2440-2590	x	1981-2136	-	-	-	3946
2440-2590	x	2137-2286	-	-	-	3946
2591-2744	x	1931-1980	-	-	-	4180
2591-2744	x	1981-2136	-	-	-	4180
2591-2744	x	2137-2286	-	-	-	4180
2745-2896	x	1931-1980	-	-	-	4510
2745-2896	x	1981-2136	-	-	-	4510
2745-2896	x	2137-2286	-	-	-	4510
2897-3049	x	1931-1980	-	-	-	4776
2897-3049	x	1981-2136	-	-	-	4776
2897-3049	x	2137-2286	-	-	-	4776

Orders for purpose made sizes will only be accepted as nominal door size for unframed version and overall frame size when ordering a framed version. Orders for purpose made framed doors will not be accepted as nominal door size. Please note that doors with windows may have cross bracing or locking rods passing behind the windows depending upon size and gear type. For further options please see page 24.

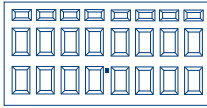
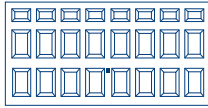
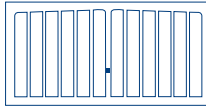
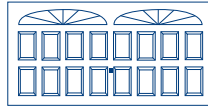
Double door					
Nominal Door Size Width x Height (mm x mm)	Size Code	Arden R	Kenmore R	Penshurst R	Stamford R
3354 x 1981	1166	3935	4093	-	-
3354 x 2136	1170	3935	4093	-	-
3354 x 2286	1176	3935	-	-	-
3659 x 1981	1266	4260 <sup>1</sup>	4446 <sup>1</sup>	-	-
3659 x 2136	1270	4260 <sup>1</sup>	4446 <sup>1</sup>	-	-
3659 x 2286	1276	4260	-	-	-
3964 x 1981	1366	4576 <sup>1</sup>	4801 <sup>1</sup>	-	-
3964 x 2136	1370	4576 <sup>1</sup>	4801 <sup>1</sup>	-	-
3964 x 2286	1376	4576	-	-	-
4269 x 1981	1466	4893	5169	5385	5405 <sup>1</sup>
4269 x 2136	1470	4893	5169	5385	5405 <sup>1</sup>
4269 x 2286	1476	4893	-	-	-

<sup>1</sup> Doors only available with electric operation (Handle and Locking not available).

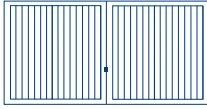
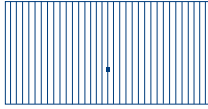
Double door			
Nominal Door Size Width x Height (mm x mm)	Size Code	Swinton R	Somerset R
3354 x 1981	1166	-	4093
3354 x 2136	1170	-	4093
3354 x 2286	1176	-	-
3659 x 1981	1266	-	4446
3659 x 2136	1270	-	4446
3659 x 2286	1276	-	-
3964 x 1981	1366	-	4801
3964 x 2136	1370	-	4801
3964 x 2286	1376	-	-
4269 x 1981	1466	-	5247
4269 x 2136	1470	5405	5247
4269 x 2286	1476	-	-

<sup>1</sup> Doors only available with electric operation (Handle and Locking not available).

Please note that doors with windows may have cross bracing or locking rods passing behind the windows depending upon size and gear type.

For further options please see page 24.

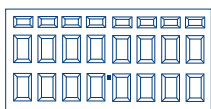
**Double door**Nominal Door Size  
Width x Height  
(mm x mm)

Arden

R

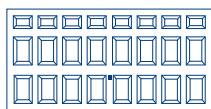

Kenmore

R

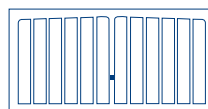

Penshurst

R

3050-3355	x	1981-2136	4204	4374	-
3050-3355	x	2137-2286	4357	-	-
3356-3660	x	1981-2136	4517 <sup>1</sup>	4729 <sup>1</sup>	-
3356-3660	x	2137-2286	4672	-	-
3661-3965	x	1981-2136	4834 <sup>1</sup>	5084 <sup>1</sup>	-
3661-3965	x	2137-2286	4990	-	-
3966-4117	x	1981-2136	5149 <sup>1</sup>	5424 <sup>1</sup>	-
3966-4117	x	2137-2286	5149	-	-
4118-4269	x	1981-2136	5149	5424	5649
4118-4269	x	2137-2286	5449	-	-

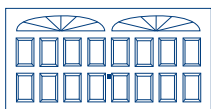
<sup>1</sup> Doors only available with electric operation (Handle and Locking not available).**Double door**Nominal Door Size  
Width x Height  
(mm x mm)

Stamford

R

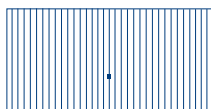

Somerset

R

3050-3355	x	1981-2136	-	4374
3050-3355	x	2137-2286	-	4374
3356-3660	x	1981-2136	-	4729
3356-3660	x	2137-2286	-	4729
3661-3965	x	1981-2136	-	5084
3661-3965	x	2137-2286	-	5084
3966-4117	x	1981-2136	-	5424
3966-4117	x	2137-2286	-	5424
4118-4269	x	1981-2136	5685 <sup>1</sup>	5649
4118-4269	x	2137-2286	-	5649







<sup>1</sup> Doors only available with electric operation (Handle and Locking not available).

Orders for purpose made sizes will only be accepted as nominal door size for unframed version and overall frame size when ordering a framed version. Orders for purpose made framed doors will not be accepted as nominal door size.

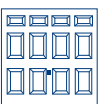
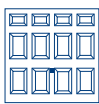







**Options**

	Single doors add	Double doors add
Factory pre-framed standard single doors	184	-
Steel frame for standard double doors	-	276
Factory pre-framed purpose-made single doors	208	-
Steel frame for purpose-made double doors	-	306
Additional Lock Kit, C-type/ R-type (fitted onto door)	86	-
Retractable plus gear available on 1931, 1981 and 2136 mm high doors up to 2744 mm wide	88	-
Diecast metal handles with matching base plates: brass effect, brushed steel, chrome effect and white	128	128
Surcharge for Premium colours Green and Blue	420	834
Surcharge for steel frame in colour not matching garage door	182	284
Surcharge for colour steel frame on Matt or Gloss White Garage door	182	284



GRP Window options for standard and purpose-made single doors				Additional Cost (Width mm)	
				up to 2743	2744-3049
 Clear Perspex	X	X	X	228	337
 Stippled Perspex	X	X	X	229	337
 Stippled Perspex with diamond leading	-	X	X	374	549
 Stippled Perspex with square leading	-	X	X	374	549
 Black Non-Translucent	X	X	X	229	337
 Black Non-Translucent Perspex with border and diamond leading	-	X	X	374	549

Please state window code on order.

GRP Window options for standard and purpose-made double doors				Additional Cost (Width mm)	
				3354 - 3963	3964 - 4269
 Clear Perspex	X	X	X	395	450
 Stippled Perspex	X	X	X	395	450
 Stippled Perspex with diamond leading	-	X	X	643	771
 Stippled Perspex with square leading	-	X	X	643	771
 Black Non-Translucent	X	X	X	395	450
 Black Non-Translucent Perspex with border and diamond leading	-	X	X	643	771

Please state window code on order.

Please note that doors with windows may have cross bracing or locking rods passing behind the windows depending upon size and gear type.

# Timber Panel Doors

## Surface

Timber doors are supplied untreated and require immediate on-site finishing unless fully finished option specified. Timber is a natural material and therefore Garador cannot guarantee to be able to produce matching timber garage doors. Chassis colours will be Brown (RAL 8028) on all timber doors

Please note: panel doors are produced with appearance in mind. This may result in some small gaps which could allow water ingress especially in exposed locations.

## Handle

Black handle and base plate supplied as standard, optional handles available. Doors can alternatively be supplied undrilled and without handle and locking mechanism for use with electric operator.

## Packaging

Supplied wrapped with additional foam protection on surface of panel as standard.

## Terminology

**Nominal Door Size:** This is the actual door panel size plus the fitting tolerances. The nominal door size should be used for internal dimensions of a timber frame.

**Size Code:** This has traditionally been used to order doors. This may not be the actual door size.

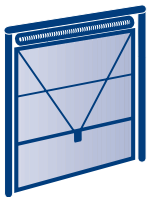

### Canopy gearing (shown as C)

Canopy gear is available for all single doors providing a reliable and affordable gearing solution, with no tracks running back into the garage.

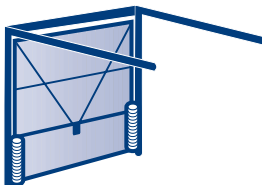

### Retractable gearing (shown as R)

Retractable gear is available for all single and double doors providing a reliable and affordable gearing solution, with tracks running back into the garage.

### Single door

Nominal Door Size  
Width x Height  
(mm x mm)

Size  
Code

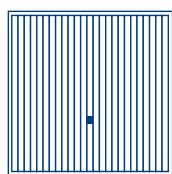

Vertical Timber

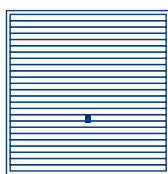

Horizontal Timber

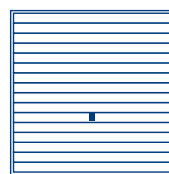

Countryman

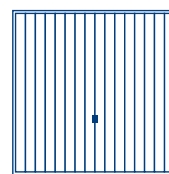

Hampton

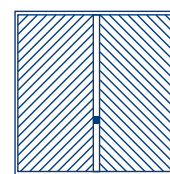

Chevron Timber

Nominal Door Size Width x Height (mm x mm)	Size Code	Vertical Timber		Horizontal Timber		Countryman		Hampton		Chevron Timber	
		C	R	C	R	C	R	C	R	C	R
2134 x 1981	7066	2899	2948	3050	3099	3620	3669	3620	3669	4310	4359
2134 x 2136	7070	2928	2977	3077	3126	3650	3699	3650	3699	4379	4428
2134 x 2286	7076	-	3313	-	3480	-	4104	-	4104	-	4622
2259 x 1981	7566	3050	3099	3209	3258	3807	3856	3807	3856	4598	4647
2259 x 2136	7570	3078	3127	3240	3289	3840	3889	3840	3889	4620	4669
2284 x 1981	7666	3050	3099	3516	3565	3807	3856	3807	3856	4598	4647
2284 x 2136	7670	3078	3127	3240	3289	3840	3889	3840	3889	4620	4669
2284 x 2286	7676	-	3436	-	3614	-	4117	-	4117	-	4848
2439 x 1981	8066	3229	3278	3398	3447	4025	4074	4025	4074	4750	4799
2439 x 2136	8070	3252	3301	3423	3472	4057	4106	4057	4106	4777	4826
2439 x 2286	8076	-	3646	-	3824	-	4363	-	4363	-	4977
2744 x 1981	9066	-	3804	-	3998	-	4542	-	4542	-	5297
2744 x 2136	9070	-	3830	-	4021	-	4591	-	4591	-	5372
2744 x 2286	9076	-	4178	-	4394	-	4915	-	4915	-	5552
3049 x 1981	1066	-	4404	-	4620	-	5130	-	5130	-	5946
3049 x 2136	1070	-	4444	-	4671	-	5172	-	5172	-	5993

### Single door

Nominal Door Size  
Width x Height  
(mm x mm)

Size  
Code

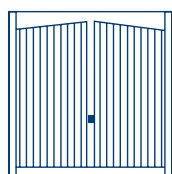

Barrington

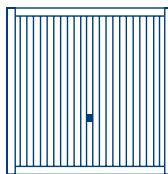

Kingsbury

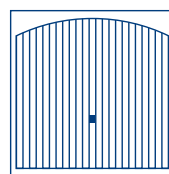

Adlington



Ashton<sup>1</sup>

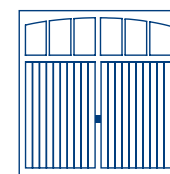

Rochdale<sup>1</sup>

Nominal Door Size Width x Height (mm x mm)	Size Code	Barrington		Kingsbury		Adlington		Ashton <sup>1</sup>		Rochdale <sup>1</sup>	
		C	R	C	R	C	R	C	R	C	R
2134 x 1981	7066	3681	3730	3650	3699	3317	3366	4310	4359	4355	4404
2134 x 2136	7070	3704	3753	3679	3728	3317	3366	4379	4428	4385	4434
2134 x 2286	7076	-	4103	-	4067	-	3666	-	4622	-	4678
2259 x 1981	7566	3827	3876	3795	3844	3461	3510	4598	4647	4515	4564
2259 x 2136	7570	3851	3900	3824	3873	3483	3532	4620	4669	4537	4586
2284 x 1981	7666	3827	3876	3795	3844	3461	3510	4598	4647	4515	4564
2284 x 2136	7670	3851	3900	3824	3873	3483	3532	4620	4669	4537	4586
2284 x 2286	7676	-	4239	-	4208	-	3830	-	4848	-	4766
2439 x 1981	8066	3961	4010	3927	3976	3807	3856	4750	4799	4658	4707
2439 x 2136	8070	3987	4036	3956	4005	3807	3856	4777	4826	4696	4745
2439 x 2286	8076	-	4363	-	4325	-	3901	-	4977	-	4885
2744 x 1981	9066	-	4518	-	4367	-	4058	-	5297	-	5330
2744 x 2136	9070	-	4558	-	4404	-	4058	-	5372	-	5415
2744 x 2286	9076	-	4913	-	4766	-	4379	-	5552	-	5586
3049 x 1981	1066	-	5109	-	4959	-	4386	-	5946	-	5990
3049 x 2136	1070	-	5152	-	4999	-	4386	-	5993	-	6032

<sup>1</sup> Ashton and Rochdale doors may have cross bracing and / or locking rods behind the windows depending upon the size and gear type.

For further options please see page 35.

Single door

Nominal Door Size  
Width x Height  
(mm x mm)

Size  
Code

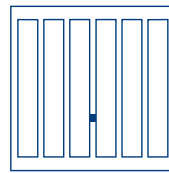
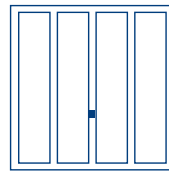
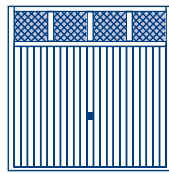

Sandhurst<sup>1</sup>

Shaftesbury

Grantham

Seymour

C

R

C

R

C

R

C

R

Nominal Door Size Width x Height (mm x mm)	Size Code	C	R	C	R	C	R	C	R
2134 x 1981	7066	4222	4271	3272	3321	2204	2253	3124	3173
2134 x 2136	7070	4248	4297	3290	3339	2204	2253	3154	3203
2134 x 2286	7076	-	4537	-	3540	-	2429	-	3392
2259 x 1981	7566	4378	4427	3335	3384	2346	2395	3192	3241
2259 x 2136	7570	4404	4453	3357	3406	2346	2395	3217	3266
2284 x 1981	7666	4378	4427	3335	3384	2346	2395	3192	3241
2284 x 2136	7670	4404	4453	3357	3406	2346	2395	3217	3266
2284 x 2286	7676	-	4630	-	3585	-	2596	-	3443
2439 x 1981	8066	4523	4572	3390	3439	2435	2484	3246	3295
2439 x 2136	8070	4559	4608	3419	3468	2435	2484	3272	3321
2439 x 2286	8076	-	4749	-	3617	-	2699	-	3473
2744 x 1981	9066	-	5125	-	4103	-	2765	-	3928
2744 x 2136	9070	-	5209	-	4137	-	2765	-	3956
2744 x 2286	9076	-	5384	-	4329	-	2956	-	4120
3049 x 1981	1066	-	5783	-	4613	-	3004	-	4426
3049 x 2136	1070	-	5825	-	4656	-	3004	-	4429

<sup>1</sup> Sandhurst doors may have cross bracing and/or locking rods behind the windows depending upon the size and gear type.

Single door

Nominal Door Size  
Width x Height  
(mm x mm)

Size  
Code

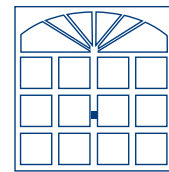
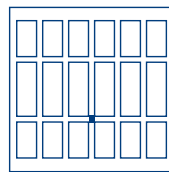
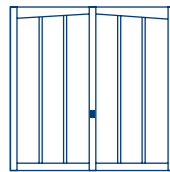
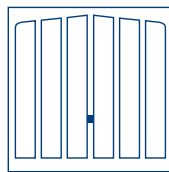

Tudor

Bosworth

Wolsley

Hinton<sup>2</sup>

C

R

C

R

C

R

C

R

Nominal Door Size Width x Height (mm x mm)	Size Code	C	R	C	R	C	R	C	R
2134 x 1981	7066	3272	3321	3314	3363	3269	3318	4532	4581
2134 x 2136	7070	3290	3339	3336	3385	3288	3337	4560	4609
2134 x 2286	7076	-	3540	-	3582	-	3535	-	4806
2259 x 1981	7566	3335	3384	3380	3429	3332	3381	4816	4865
2259 x 2136	7570	3357	3406	3405	3454	3353	3402	4843	4892
2284 x 1981	7666	3335	3384	3380	3429	3332	3381	4816	4865
2284 x 2136	7670	3357	3406	3405	3454	3353	3402	4843	4892
2284 x 2286	7676	-	3585	-	3633	-	3583	-	5064
2439 x 1981	8066	3390	3439	3433	3482	3387	3436	4958	5007
2439 x 2136	8070	3419	3468	3455	3504	3410	3459	4989	5038
2439 x 2286	8076	-	3617	-	3662	-	3615	-	5184
2744 x 1981	9066	-	4103	-	4146	-	4001	-	5599
2744 x 2136	9070	-	4137	-	4174	-	4032	-	5629
2744 x 2286	9076	-	4329	-	4369	-	4196	-	5816
3049 x 1981	1066	-	4613	-	4656	-	4470	-	6326
3049 x 2136	1070	-	4656	-	4696	-	4474	-	6363

<sup>2</sup> Hinton doors may have cross bracing and/or locking rods behind the windows depending upon the size and gear type.

For further options please see page 35.

### Single door

Nominal Door Size  
Width x Height  
(mm x mm)

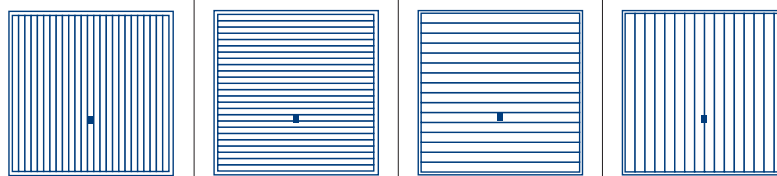

Vertical Timber      Horizontal Timber      Countryman      Hampton

		Vertical Timber		Horizontal Timber		Countryman		Hampton	
		C	R	C	R	C	R	C	R
1930-1984	x 1931-1981	3155	3204	3316	3365	4415	4464	4415	4464
1930-1984	x 1982-2136	3175	3224	3341	3390	4542	4591	4542	4591
1930-1984	x 2137-2286	-	3558	-	3737	-	4920	-	4920
1930-1984	x 2287-2439	-	3646	-	3824	-	5276	-	5276
1985-2284	x 1931-1981	3299	3348	3471	3520	4652	4701	4652	4701
1985-2284	x 1982-2136	3325	3374	3497	3546	4798	4847	4798	4847
1985-2284	x 2137-2286	-	3681	-	3862	-	5167	-	5167
1985-2284	x 2287-2439	-	3767	-	3953	-	5591	-	5591
2285-2439	x 1931-1981	3473 <sup>1</sup>	3522	3656 <sup>1</sup>	3705	4719 <sup>1</sup>	4768	4719 <sup>1</sup>	4768
2285-2439	x 1982-2136	3497 <sup>1</sup>	3546	3681 <sup>1</sup>	3730	4860 <sup>1</sup>	4909	4860 <sup>1</sup>	4909
2285-2439	x 2137-2286	-	3883	-	-	-	-	-	-
2285-2439	x 2287-2439	-	4032	-	-	-	-	-	-
2440-2744	x 1931-1981	-	4040	-	-	-	-	-	-
2440-2744	x 1982-2136	-	4067	-	-	-	-	-	-
2440-2744	x 2137-2286	-	4411	-	-	-	-	-	-
2440-2744	x 2287-2439	-	4532	-	-	-	-	-	-
2745-3049	x 1931-1981	-	4625	-	-	-	-	-	-
2745-3049	x 1982-2136	-	4673	-	-	-	-	-	-

<sup>1</sup> These doors are not available over 2438 mm wide.

### Single door

Nominal Door Size  
Width x Height  
(mm x mm)

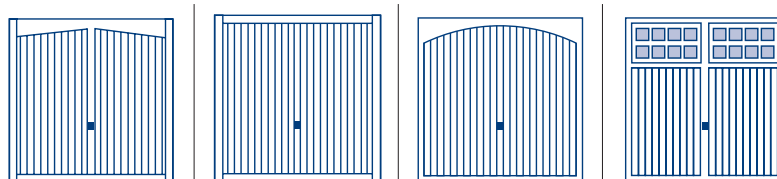

Barrington      Kingsbury      Adlington      Ashton<sup>2</sup>

		Barrington		Kingsbury		Adlington		Ashton <sup>2</sup>	
		C	R	C	R	C	R	C	R
1930-1984	x 1931-1981	3990	4039	3962	4011	3405	3454	4633	4682
1930-1984	x 1982-2136	4013	4062	3989	4038	3428	3477	4658	4707
1930-1984	x 2137-2286	-	4415	-	4378	-	3807	-	5050
1930-1984	x 2287-2439	-	4497	-	4474	-	3893	-	5145
1985-2284	x 1931-1981	4133	4182	4108	4157	3553	3602	4781	4830
1985-2284	x 1982-2136	4162	4211	4130	4179	3578	3627	4803	4852
1985-2284	x 2137-2286	-	4556	-	4518	-	3934	-	5190
1985-2284	x 2287-2439	-	4635	-	4613	-	4014	-	5284
2285-2439	x 1931-1981	4268 <sup>1</sup>	4317	4236 <sup>1</sup>	4285	3725 <sup>1</sup>	3774	4909	4958
2285-2439	x 1982-2136	4291 <sup>1</sup>	4340	4265 <sup>1</sup>	4314	3750 <sup>1</sup>	3799	4938	4987
2285-2439	x 2137-2286	-	4675	-	4634	-	4137	-	5309
2285-2439	x 2287-2439	-	4791	-	4766	-	4281	-	5439
2440-2744	x 1931-1981	-	4830	-	4680	-	4294	-	5352
2440-2744	x 1982-2136	-	4864	-	4715	-	4313	-	5384
2440-2744	x 2137-2286	-	5231	-	5079	-	4665	-	5750
2440-2744	x 2287-2439	-	5346	-	5197	-	4783	-	5868
2745-3049	x 1931-1981	-	5420	-	5269	-	4879	-	5942
2745-3049	x 1982-2136	-	5467	-	5311	-	4920	-	5982

<sup>1</sup> These doors are not available over 2438 mm wide.

<sup>2</sup> Ashton doors may have cross bracing and / or locking rods behind the windows depending upon the size and gear type.

Orders for purpose made sizes will only be accepted as nominal door size for unframed version and overall frame size when ordering a framed version. Orders for purpose made framed doors will not be accepted as nominal door size. For further options please see page 35.

### Single door

Nominal Door Size  
Width x Height  
(mm x mm)

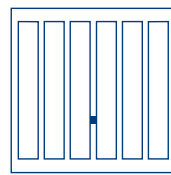
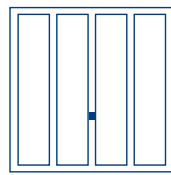

Shaftesbury

Grantham

Seymour

		Shaftesbury		Grantham		Seymour	
		C	R	C	R	C	R
1930-1984	x 1931-1981	3435	3484	2883	2932	3435	3484
1930-1984	x 1982-2136	3461	3510	2909	2958	3461	3510
1930-1984	x 2137-2286	-	3704	-	3156	-	3704
1930-1984	x 2287-2439	-	3821	-	3270	-	3821
1985-2284	x 1931-1981	3499	3548	2951	3000	3499	3548
1985-2284	x 1982-2136	3529	3578	2979	3028	3529	3578
1985-2284	x 2137-2286	-	3755	-	3208	-	3755
1985-2284	x 2287-2439	-	3866	-	3318	-	3866
2285-2439	x 1931-1981	3558 <sup>1</sup>	3607	3010 <sup>1</sup>	3059	3558 <sup>1</sup>	3607
2285-2439	x 1982-2136	3582 <sup>1</sup>	3631	3031 <sup>1</sup>	3080	3582 <sup>1</sup>	3631
2285-2439	x 2137-2286	-	3785	-	3235	-	3785
2285-2439	x 2287-2439	-	3947	-	3394	-	3947
2440-2744	x 1931-1981	-	4236	-	3687	-	4236
2440-2744	x 1982-2136	-	4268	-	3720	-	4268
2440-2744	x 2137-2286	-	4431	-	3883	-	4431
2440-2744	x 2287-2439	-	4556	-	4002	-	4556
2745-3049	x 1931-1981	-	4740	-	4191	-	4740
2745-3049	x 1982-2136	-	4741	-	4192	-	4741

<sup>1</sup> These doors are not available over 2438 mm wide.

### Single door

Nominal Door Size  
Width x Height  
(mm x mm)

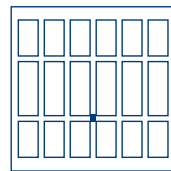
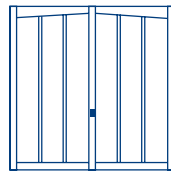
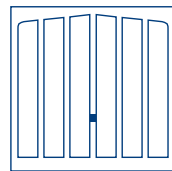

Tudor

Bosworth

Wolsey

		Tudor		Bosworth		Wolsey	
		C	R	C	R	C	R
1930-1984	x 1931-1981	3582	3631	3622	3671	3576	3625
1930-1984	x 1982-2136	3602	3651	3649	3698	3599	3648
1930-1984	x 2137-2286	-	3848	-	3892	-	3842
1930-1984	x 2287-2439	-	3962	-	4008	-	3969
1985-2284	x 1931-1981	3648	3697	3690	3739	3644	3693
1985-2284	x 1982-2136	3675	3724	3714	3763	3666	3715
1985-2284	x 2137-2286	-	3899	-	3945	-	3893
1985-2284	x 2287-2439	-	4013	-	4058	-	4023
2285-2439	x 1931-1981	3702 <sup>1</sup>	3751	3741 <sup>1</sup>	3790	3696 <sup>1</sup>	3745
2285-2439	x 1982-2136	3725 <sup>1</sup>	3774	3768 <sup>1</sup>	3817	3723 <sup>1</sup>	3772
2285-2439	x 2137-2286	-	3930	-	3967	-	3927
2285-2439	x 2287-2439	-	4150	-	4192	-	4101
2440-2744	x 1931-1981	-	4415	-	4454	-	4310
2440-2744	x 1982-2136	-	4444	-	4489	-	4342
2440-2744	x 2137-2286	-	4635	-	4683	-	4506
2440-2744	x 2287-2439	-	4757	-	4801	-	4625
2745-3049	x 1931-1981	-	4925	-	4969	-	4783
2745-3049	x 1982-2136	-	4969	-	5009	-	4786

<sup>1</sup> These doors are not available over 2438 mm wide.



Orders for purpose made sizes will only be accepted as nominal door size for unframed version and overall frame size when ordering a framed version. Orders for purpose made framed doors will not be accepted as nominal door size.

For further options please see page 35.

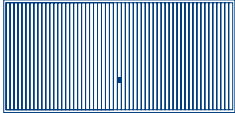
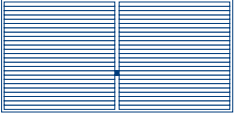
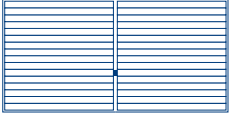
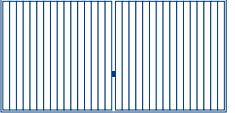
**Double door**

Nominal Door Size Width x Height (mm x mm)	Size Code				
		Vertical Timber	Horizontal Timber	Countryman	Hampton
		R	R	R	R
3049 x 2286	1076	4998	5063	6470	6470
3354 x 1981	1166	4998	5064	6405	6405
3354 x 2136	1170	5138	5208	6541	6541
3354 x 2286	1176	5556	5629	7093	7093
3659 x 1981	1266	5632	5709	7128	7128
3659 x 2136	1270	5778	5850	7266	7266
3659 x 2286	1276	6286	6368	7935	7935
3964 x 1981	1366	6657	6753	7854	7854
3964 x 2136	1370	6868	6962	8066	8066
3964 x 2286	1376	7453	7551	8771	8771
4269 x 1981	1466	6514	6610	8090	8090
4269 x 2136	1470	6657	6753	8229	8229
4574 x 1981	1566	7356	7458	-	-
4574 x 2136	1570	7566	7663	-	-
4879 x 1981	1666	8022	8129	-	-
4879 x 2136	1670	8091	8198	-	-

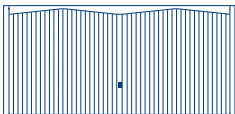
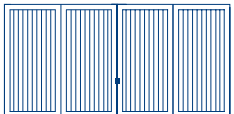
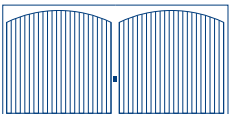
**Double door**

Nominal Door Size Width x Height (mm x mm)	Size Code				
		Barrington	Kingsbury	Adlington	Ashton <sup>1</sup>
		R	R	R	R
3049 x 2286	1076	5945	5670	5552	6605
3354 x 1981	1166	5900	5654	5446	6409
3354 x 2136	1170	6040	5794	5580	6548
3354 x 2286	1176	6548	6279	6048	7098
3659 x 1981	1266	6569	6320	6030	7361
3659 x 2136	1270	6710	6462	6167	7502
3659 x 2286	1276	7324	7083	6724	8195
3964 x 1981	1366	7643	7480	7299	8634
3964 x 2136	1370	7854	7689	7511	8846
3964 x 2286	1376	8537	8360	8163	9626
4269 x 1981	1466	7502	7341	7160	8495
4269 x 2136	1470	7643	7480	7299	8634
4574 x 1981	1566	8338	8232	-	9361
4574 x 2136	1570	8549	8442	-	9568
4879 x 1981	1666	9004	8901	-	10136
4879 x 2136	1670	9078	8972	-	10203

<sup>1</sup> Ashton doors may have cross bracing and/or locking rods behind the windows depending upon the size and gear type.

For further options please see page 35.

**Double door**

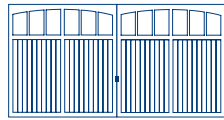
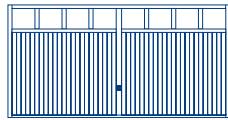
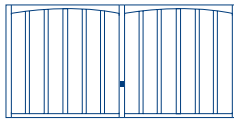
Nominal Door Size Width x Height (mm x mm)	Size Code			
		Rochdale <sup>1,2</sup>	Sandhurst <sup>1</sup>	Shaftesbury
		R	R	R
3049 x 2286	1076	6986	6141	4828
3354 x 1981	1166	6757	6101	4766
3354 x 2136	1170	6899	6241	4906
3354 x 2286	1176	7488	6770	5300
3659 x 1981	1266	7709	6883	5290
3659 x 2136	1270	7854	7024	5429
3659 x 2286	1276	8578	7663	5908
3964 x 1981	1366	8987	8033	6160
3964 x 2136	1370	9199	8239	6369
3964 x 2286	1376	10006	8966	6899
4269 x 1981	1466	8846	7888	6020
4269 x 2136	1470	8987	8033	6160
4574 x 1981	1566	10012	8972	6899
4574 x 2136	1570	10223	9185	7109
4879 x 1981	1666	10696	9953	7670
4879 x 2136	1670	10764	10028	7744

<sup>1</sup> Rochdale and Sandhurst doors may have cross bracing and/or locking rods behind the windows depending upon the size and gear type.

<sup>2</sup> Rochdale doors up to 3659 mm wide will be manufactured with one arch not the two as shown above.

**Double door**

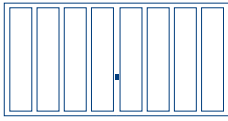
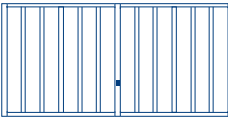
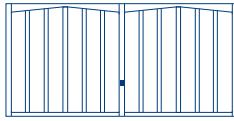
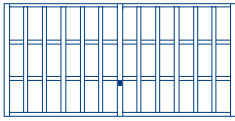
Nominal Door Size Width x Height (mm x mm)	Size Code				
		Grantham	Seymour	Tudor	Wolsey
		R	R	R	R
3049 x 2286	1076	4226	4780	4828	5420
3354 x 1981	1166	4138	4627	4766	5365
3354 x 2136	1170	4277	4766	4906	5506
3354 x 2286	1176	4609	5145	5300	5900
3659 x 1981	1266	4678	5222	5290	5888
3659 x 2136	1270	4819	5359	5429	6030
3659 x 2286	1276	5236	5835	5908	6503
3964 x 1981	1366	5236	6087	6160	6758
3964 x 2136	1370	5446	6299	6369	6969
3964 x 2286	1376	5879	6827	6899	7496
4269 x 1981	1466	5094	5945	6020	6618
4269 x 2136	1470	5236	6087	6160	6758
4574 x 1981	1566	-	-	6899	7496
4574 x 2136	1570	-	-	7109	7705
4879 x 1981	1666	-	-	7670	8271
4879 x 2136	1670	-	-	7744	8338

For further options please see page 35.



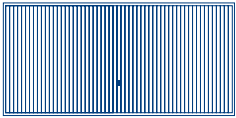
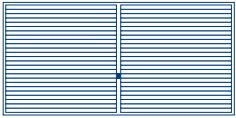
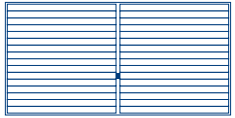
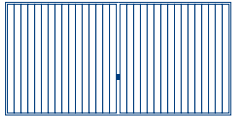

### Double door

Nominal Door Size  
Width x Height  
(mm x mm)

				
	Vertical Timber	Horizontal Timber	Countryman	Hampton
	R	R	R	R
2745-3049 x 2137-2286	-	-	-	-
3050-3659 x 1931-1981	6195	6279	7604	7604
3050-3659 x 1982-2136	6349	6434	7755	7755
3050-3659 x 2137-2286	6912	7006	8472	8472
3660-4269 x 1931-1981	7551	7658	9007	9007
3660-4269 x 1982-2136	7789	7888	9238	9238
3660-4269 x 2137-2286	8176	8285	9700	9700
4270-5000 x 1931-1981	8826	8939	-	-
4270-5000 x 1982-2136	8901	9016	-	-

### Double door

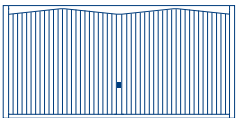
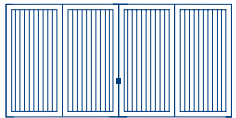
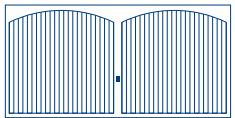
Nominal Door Size  
Width x Height  
(mm x mm)

				
	Barrington	Kingsbury	Adlington	Ashton <sup>1</sup>
	R	R	R	R
2745-3049 x 2137-2286	-	-	-	7257
3050-3659 x 1931-1981	7223	6955	6625	8094
3050-3659 x 1982-2136	7378	7109	6781	8250
3050-3659 x 2137-2286	8053	7789	7391	9007
3660-4269 x 1931-1981	8638	8465	8263	9729
3660-4269 x 1982-2136	8870	8694	8494	9959
3660-4269 x 2137-2286	9313	9124	8917	10456
4270-5000 x 1931-1981	9906	9792	-	11142
4270-5000 x 1982-2136	9987	9867	-	11219

<sup>1</sup> Ashton doors may have cross bracing and/or locking rods behind the windows depending upon the size and gear type.

Orders for purpose made sizes will only be accepted as nominal door size for unframed version and overall frame size when ordering a framed version. Orders for purpose made framed doors will not be accepted as nominal door size.

For further options please see page 35.

**Double door**

Nominal Door Size  
Width x Height  
(mm x mm)

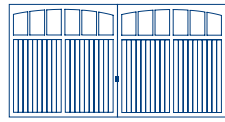

Rochdale<sup>1,2</sup>

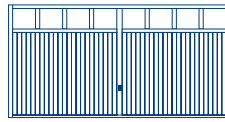

Sandhurst<sup>1</sup>

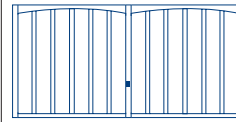

Shaftesbury

	R	R	R
2745-3049 x 2137-2286	7684	6753	5301
2745-3049 x 2287-2439	8074	7090	5572
3050-3659 x 1931-1981	8483	7572	5816
3050-3659 x 1982-2136	8638	7727	5970
3050-3659 x 2137-2286	9434	8429	6498
3050-3659 x 2287-2439	9901	8849	6821
3660-4269 x 1931-1981	10117	9064	7007
3660-4269 x 1982-2136	10348	9295	7240
3660-4269 x 2137-2286	10864	9758	7603
3660-4269 x 2287-2439	11381	10223	7960
4270-5000 x 1931-1981	11764	10951	8436
4270-5000 x 1982-2136	11839	11027	8516

<sup>1</sup> Rochdale and Sandhurst doors may have cross bracing and/or locking rods behind the windows depending upon the size and gear type.

<sup>2</sup> Rochdale doors up to 3659 mm wide will be manufactured with one arch not the two as shown above.

**Double door**

Nominal Door Size  
Width x Height  
(mm x mm)

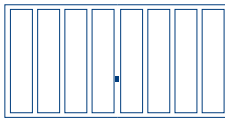

Grantham

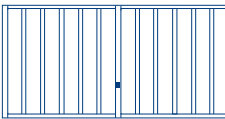

Seymour

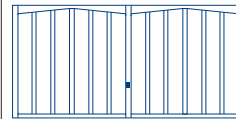

Tudor

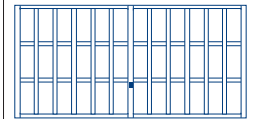



Wolsey

	R	R	R	R
2745-3049 x 2137-2286	4646	5257	5301	5901
2745-3049 x 2287-2439	4880	5521	5572	6168
3050-3659 x 1931-1981	5139	5738	5816	6414
3050-3659 x 1982-2136	5298	5893	5970	6569
3050-3659 x 2137-2286	5753	6420	6498	7093
3050-3659 x 2287-2439	6040	6740	6821	7413
3660-4269 x 1931-1981	5985	6927	7007	7606
3660-4269 x 1982-2136	6216	7163	7240	7833
3660-4269 x 2137-2286	6531	7519	7603	8198
3660-4269 x 2287-2439	6841	7878	7960	8559
4270-5000 x 1931-1981	-	-	8436	9034
4270-5000 x 1982-2136	-	-	8516	9110

Orders for purpose made sizes will only be accepted as nominal door size for unframed version and overall frame size when ordering a framed version. Orders for purpose made framed doors will not be accepted as nominal door size.

For further options please see page 35.

Timber door window options Prices in £ stated per door						
	Standard		Georgian <sup>1</sup>		Diagonal <sup>1</sup>	
	Single doors	Double doors	Single doors	Double doors	Single doors	Double doors
Plain	no on-cost	no on-cost	176	243	176	243
Crystal	no on-cost	no on-cost	176	243	176	243

<sup>1</sup> Only available on Sandhurst.

Windows are manufactured from 4 mm acrylic panes. Please state on order if clear or stippled panes required.

Options	Single doors	Double doors
	add	add
Factory pre-framed standard single doors	184	-
Steel frame for standard double doors	-	276
Factory pre-framed purpose-made single doors	208	-
Steel frame for purpose-made double doors	-	306
Additional Lock Kit, C-type/ R-type (fitted onto door)	86	-
Factory fully finished stain in Light Oak, Antique Oak, Mahogany, Walnut, Chestnut and Ebony	239	354
Factory white primer ready for on-site painting	324	494
Factory fully finished painting (any RAL colour timber only)	535	927
Diecast metal handles with matching base plates: brass effect, chrome effect, brushed steel and white	128	128
Bottom weatherseal, 2405 mm length (suitable for gaps up to 15 mm between the door and the floor level)	63	63
Bottom weatherseal, 3000 mm length (suitable for gaps up to 15 mm between the door and the floor level)	70	70
Surcharge for colour steel Chassis and/or frame finished in RAL colour (no additional charge for Brown RAL8028 or White RAL9016 chassis and frame)	182	284

Please note, retractable plus lifting gear is not available on timber up and over garage doors.

# Steel and Timber Garage Side Doors

## Surface

Steel doors constructed around a strong steel box section chassis in Traffic White (RAL 9016) as standard. Timber doors constructed using timber, built around a strong steel box section chassis. A range of stain options are available.







## Handle

Supplied with lever/lever handle on left side (viewed outside)

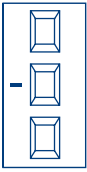
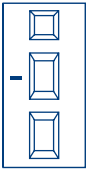
## Terminology

Nominal Door Size: This is the actual door panel size plus the fitting tolerances. The nominal door size should be used for internal dimensions of a timber frame.

Size Code: This has traditionally been used to order doors. This may not be the actual door size.

Steel door - standard sizes									
Nominal Door Size Width x Height (mm x mm)	Overall frame size (between fix) <sup>1</sup> Width x Height (mm x mm)	Size Code	Georgian	Beaumont	Cathedral	Beaumont with Windows <sup>2</sup>	Carlton	Ascot	Windsor
732 x 1905	882 x 1991	2664	1127	1127	1127	1243	933	1127	1127
732 x 1955	882 x 2041	2666	1149	1149	1149	1262	952	1149	1149
732 x 2110	882 x 2196	2670	1177	1177	1177	1292	979	1177	1177
884 x 1905	1034 x 1991	3064	1167	1167	1167	1282	969	1167	1167
884 x 1955	1034 x 2041	3066	1189	1189	1189	1300	991	1189	1189
884 x 2110	1034 x 2196	3070	1219	1219	1219	1334	1022	1219	1219
1037 x 1905	1187 x 1991	3664	1207	1207	1207	1323	1009	1207	1207
1037 x 1955	1187 x 2041	3666	1230	1230	1230	1341	1032	1230	1230
1037 x 2110	1187 x 2196	3670	1255	1255	1255	1372	1059	1255	1255
1170 x 1905	1320 x 1991	4064	1247 <sup>3</sup>	1247 <sup>3</sup>	1247 <sup>3</sup>	1358 <sup>3</sup>	1048	1247	1247
1170 x 1955	1320 x 2041	4066	1265 <sup>3</sup>	1265 <sup>3</sup>	1265 <sup>3</sup>	1381 <sup>3</sup>	1071	1265	1265
1170 x 2110	1320 x 2196	4070	1279 <sup>3</sup>	1279 <sup>3</sup>	1279 <sup>3</sup>	1392 <sup>3</sup>	1096	1279	1279

<sup>1</sup> No fitting clearance allowed.

<sup>2</sup> Windows for Beaumont: Standard () , Diamond () , Cross () . Please state on order if plain or crystal panes.

<sup>3</sup> Doors over 1210 mm overall frame width have two vertical columns of panel pressings. These doors vary from images shown.

### Steel door - purpose-made sizes

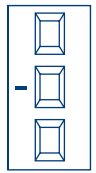
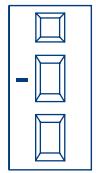
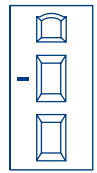
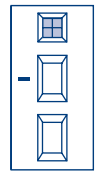
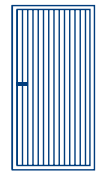
Nominal Door Size Width x Height (mm x mm)	Overall frame size (between fix) <sup>1</sup> Width x Height (mm x mm)	 Georgian <sup>3</sup>	 Beaumont <sup>3</sup>	 Cathedral <sup>3</sup>	 Beaumont with Windows <sup>2,3</sup>	 Carlton
670-1036 x 1905-2110	820-1186 x 1991-2196	1404 <sup>4</sup>	1404 <sup>4</sup>	1404 <sup>4</sup>	1565 <sup>4</sup>	1230
1037-1310 x 1905-2110	1187-1320 x 1991-2196	1484	1484	1484	1642	1304

<sup>1</sup> No fitting clearance allowed.



<sup>2</sup> Windows for Beaumont: Standard , Diamond , Cross . Please state on order if plain or crystal panes.

<sup>3</sup> Purpose-made Georgian, Beaumont and Cathedral models have two panel pressings on door design when overall frame width is over 1210 mm.

<sup>4</sup> Cathedral, Beaumont and Georgian are available at a minimum overall frame size of 882 mm.

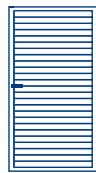
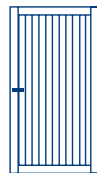

All doors come factory pre-framed, right hand hinged with the handle on the left as standard (viewed from outside). Supplied with lever/lever handle set. Doors only available to open outwards.

### Timber door - standard sizes

Nominal Door Size Width x Height (mm x mm)	Overall frame size (between fix) <sup>1</sup> Width x Height (mm x mm)	Size Code	 Vertical Timber	 Horizontal Timber	 Kingsbury	 Seymour
732 x 1905	882 x 1991	2664	2733	2799	2971	2733
732 x 1955	882 x 2041	2666	2769	2833	3000	2769
732 x 2110	882 x 2196	2670	2818	2875	3043	2818
884 x 1905	1034 x 1991	3064	2833	2892	3058	2833
884 x 1955	1034 x 2041	3066	2861	2921	3092	2861
884 x 2110	1034 x 2196	3070	2907	2971	3133	2907
1037 x 1905	1187 x 1991	3664	2921	2982	3156	2921
1037 x 1955	1187 x 2041	3666	2951	3016	3182	2951
1037 x 2110	1187 x 2196	3670	3000	3058	3227	3000
1170 x 1905	1320 x 1991	4064	3016	3073	3241	3016
1170 x 1955	1320 x 2041	4066	3043	3108	3276	3043
1170 x 2110	1320 x 2196	4070	3092	3156	3314	3092

<sup>1</sup> No fitting clearance allowed.

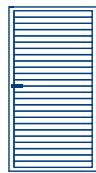
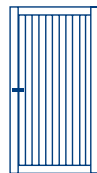
### Timber door - purpose-made sizes

Nominal Door Size Width x Height (mm x mm)	Overall frame size (between fix) <sup>1</sup> Width x Height (mm x mm)	 Vertical Timber	 Horizontal Timber	 Kingsbury <sup>2</sup>	 Seymour
670-1036 x 1905-2110	820-1186 x 1991-2196	3303	3367	3531	3303
1037-1310 x 1905-2110	1187-1320 x 1991-2196	3486	3547	3710	3486

<sup>1</sup> No fitting clearance allowed.

<sup>2</sup> Minimum overall frame width for Kingsbury is 826 mm.

# Steel and Timber Side-hinged Doors

## Surface

Steel Side-hinged doors are constructed around a strong steel box section chassis in Traffic White (RAL 9016) as standard. Timber doors constructed using timber, built around our steel box section chassis. A range of stain options are available.

## Pre-Framed Design and Concealed Hinges

All doors come factory pre-framed with 75mm wide door frame and right-hand door leaf leading as standard. Hinges are concealed in the frame, with no hinge knuckles protruding above the surface of the door.

## Two-Point Locking

A shoot bolt latch is used to secure the fixed door leaf at the top and bottom.

## Door Stays and Gas Pistons

Supplied complete with solid metal door stays and pull cord release. Gas pistons are fitted to each door leaf for a controlled closing motion.

## Rubber weather seals

Sturdy rubber weather seals all built into the door frame and along the door stop on the fixed and leading door leaf.

## Aluminium threshold

A 20 mm aluminium threshold is supplied as standard at the base of the door.

## Steel Colours

Standard colours are:

- Traffic White (RAL 9016)

Optional colours available on an approximate 4 week lead-time:

- |                          |                              |                          |                             |
|--------------------------|------------------------------|--------------------------|-----------------------------|
| - Light Ivory (RAL 1015) | - Moss Green (RAL 6005)      | - Light grey (RAL 7035)  | - Burgundy Brown            |
| - Ruby Red (RAL 3003)    | - Fir Green (RAL 6009)       | - Agate Grey (RAL 7038)  | - Golden Brown              |
| - Signal Blue (RAL 5005) | - Slate Grey (RAL 7015)      | - Window Grey (RAL 7040) | - Chartwell Green (BS 4800) |
| - Steel Blue (RAL 5011)  | - Anthracite Grey (RAL 7016) | - Terra Brown (RAL 8028) |                             |
| - Pigeon Blue (RAL 5014) | - Stone Grey (RAL 7030)      | - Jet Black (RAL 9005)   |                             |

## Timber Stains

Full finished stains available as an option. Stain colours include Light Oak, Antique Oak, Mahogany, Walnut, Chestnut and Ebony

## Handle

Supplied with black lever/ lever handle on right side (viewed outside) and centrally located flip-up handle which releases shoot-bolt latches at the top and bottom of the fixed leaf (viewed inside).

## Terminology

Nominal Door Size: This is the actual door panel size plus the fitting tolerances. The nominal door size should be used for internal dimensions of a timber frame.

Size Code: This has traditionally been used to order doors. This may not be the actual door size.

## Packaging

All doors are supplied wrapped. Only steel doors are supplied unwrapped as standard with optional poly-wrapping available.

### Steel door - standard sizes

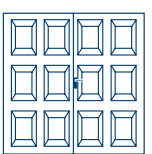
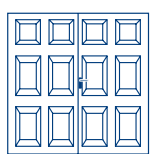
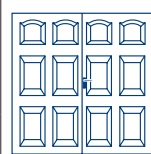
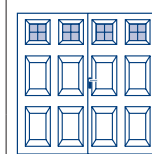
Nominal Door Size Width x Height (mm x mm)	Overall frame size (between fix) <sup>1</sup> Width x Height (mm x mm)	Size Code				
			Georgian	Beaumont	Cathedral	Beaumont with Windows <sup>2</sup>
1780 x 1806	1930 x 1891	6060	-	-	-	-
1934 x 1806	2084 x 1891	6660	-	-	-	-
1934 x 1907	2084 x 1991	6664	-	-	-	-
1934 x 1957	2084 x 2041	6666	-	-	-	-
1934 x 2112	2084 x 2196	6670	-	-	-	-
2084 x 1806	2234 x 1891	7060	-	-	-	-
2084 x 1907	2234 x 1991	7064	2220	2220	2220	2652
2084 x 1957	2234 x 2041	7066	2220	2220	2220	2652
2084 x 2112	2234 x 2196	7070	2253	2253	2253	2687
2209 x 1907	2359 x 1991	7564	2322	2322	2322	2757
2209 x 1957	2359 x 2041	7566	2322	2322	2322	2757
2209 x 2112	2359 x 2196	7570	2359	2359	2359	2791
2234 x 1907	2384 x 1991	7664	2359	2359	2359	2791
2234 x 1957	2384 x 2041	7666	2359	2359	2359	2791
2234 x 2112	2384 x 2196	7670	2390	2390	2390	2823
2389 x 1907	2539 x 1991	8064	2462	2462	2462	2894
2389 x 1957	2539 x 2041	8066	2462	2462	2462	2894
2389 x 2112	2539 x 2196	8070	2492	2492	2492	2926

### Steel door - standard sizes

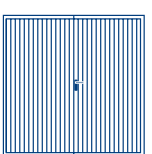
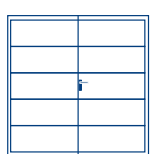
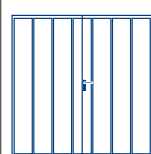
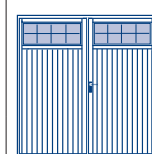
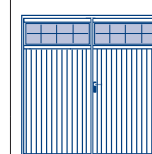
Nominal Door Size Width x Height (mm x mm)	Overall frame size (between fix) <sup>1</sup> Width x Height (mm x mm)	Size Code					
			Carlton	Ascot	Windsor	Salisbury Version 1	Salisbury Version 2
1780 x 1806	1930 x 1891	6060	1951	-	-	-	-
1934 x 1806	2084 x 1891	6660	1983	-	-	-	-
1934 x 1907	2084 x 1991	6664	2017	-	-	-	-
1934 x 1957	2084 x 2041	6666	2017	-	-	-	-
1934 x 2112	2084 x 2196	6670	2055	-	-	-	-
2084 x 1806	2234 x 1891	7060	2055	-	-	-	-
2084 x 1907	2234 x 1991	7064	2087	2220	2220	-	-
2084 x 1957	2234 x 2041	7066	<b>2087</b> <sup>3</sup>	2220	2220	2941	-
2084 x 2112	2234 x 2196	7070	<b>2121</b> <sup>3</sup>	2253	2253	2941	-
2209 x 1907	2359 x 1991	7564	2190	2322	2322	-	-
2209 x 1957	2359 x 2041	7566	2190	2322	2322	-	-
2209 x 2112	2359 x 2196	7570	2220	2359	2359	-	-
2234 x 1907	2384 x 1991	7664	2220	2359	2359	-	-
2234 x 1957	2384 x 2041	7666	2220	2359	2359	-	3001
2234 x 2112	2384 x 2196	7670	2253	2390	2390	-	3001
2389 x 1907	2539 x 1991	8064	2322	2462	2462	-	-
2389 x 1957	2539 x 2041	8066	2322	2462	2462	-	3001
2389 x 2112	2539 x 2196	8070	2359	2492	2492	-	3001

<sup>1</sup> No fitting clearance allowed.

<sup>2</sup> Windows for Beaumont: Standard , Diamond , Cross . Please state on order if plain or crystal panes.

<sup>3</sup> Carlton 7066 and 7070 stock door only available as Traffic White (RAL 9016) with right-hand leading.

All doors come factory pre-framed, right hand door leaf leading as standard (viewed from the outside) with lever/lever handle set.

Ascot, Windsor and Salisbury side-hinged garage doors are only available in 50/ 50 door leaf configuration.

The above doors are shown as 50/50 door leaves configuration. Up to 2234 mm overall frame width these doors are also available as a 1/3 2/3 door configuration. Prices are the same but please be aware panel configurations on Georgian, Beaumont & Cathedral doors will have 3 pressing columns with increased spacing between the pressing (1/3 2/3 is a term used to describe these doors but please note the 1/3 door leaf is always 800 mm wide with the 2/3 element varying to make the desired overall width). 1/3 leaf is always leading

Carlton doors are available as a 1/3, 2/3 option in overall frame sizes up to 2234 mm wide. Georgian, Beaumont, Cathedral and Beaumont with windows doors are available as a 1/3, 2/3 option only in one overall frame width, 2234 mm wide.

**Steel door -  
purpose-made sizes**

Overall frame size  
(between fix)<sup>1</sup>  
Width x Height  
(mm x mm)

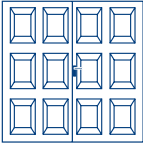
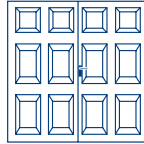
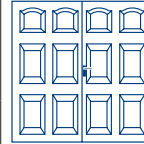
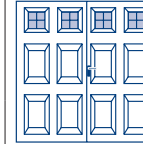
	 Georgian	 Beaumont	 Cathedral	 Beaumont with Windows <sup>2</sup>
1930 - 2233 x 1891 - 2041	-	-	-	-
1930 - 2233 x 2042 - 2196	-	-	-	-
2234 - 2384 x 1891 - 1990	-	-	-	-
2234 - 2384 x 1991 - 2041	2475	2475	2475	3010
2234 - 2384 x 2042 - 2196	2500	2500	2500	3035
2385 - 2539 x 1891 - 1990	-	-	-	-
2385 - 2539 x 1991 - 2041	2613	2613	2613	3142
2385 - 2539 x 2042 - 2196	2640	2640	2640	3175

**Steel door -  
purpose-made sizes**

Overall frame size  
(between fix)<sup>1</sup>  
Width x Height  
(mm x mm)

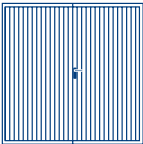
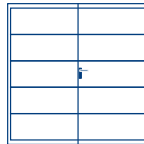
	 Carlton	 Ascot
1930 - 2233 x 1891 - 2041	2208	-
1930 - 2233 x 2042 - 2196	2264	-
2234 - 2384 x 1891 - 1990	2290	-
2234 - 2384 x 1991 - 2041	2359	2475
2234 - 2384 x 2042 - 2196	2402	2500
2385 - 2539 x 1891 - 1990	2383	-
2385 - 2539 x 1991 - 2041	2472	2613
2385 - 2539 x 2042 - 2196	2502	2640

<sup>1</sup> No fitting clearance allowed.

<sup>2</sup> Windows for Beaumont: Standard () , Diamond () , Cross () . Please state on order if plain or crystal panes.

All doors come factory pre-framed, right hand door leaf leading as standard (viewed from the outside) with lever/lever handle set.

Ascot and Windsor side-hinged garage doors are only available in 50/ 50 door leaf configuration.

The above doors are shown as 50/50 door leaves configuration. Up to 2234 mm overall frame width these doors are also available as a 1/3 2/3 door configuration. Prices are the same but please be aware panel configurations on Georgian, Beaumont & Cathedral doors will have 3 pressing columns with increased spacing between the pressing (1/3 2/3 is a term used to describe these doors but please note the 1/3 door leaf is always 800 mm wide with the 2/3 element varying to make the desired overall width). 1/3 leaf is always leading.



Carlton doors are available as a 1/3, 2/3 option in overall frame sizes up to 2234 mm wide. Georgian, Beaumont, Cathedral and Beaumont with windows doors are available as a 1/3, 2/3 option only in one overall frame width, 2234 mm wide.

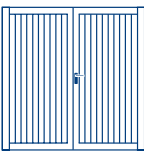

**Timber door - standard sizes**

Nominal Door Size Width x Height (mm x mm)	Overall frame size (between fix) <sup>1</sup> Width x Height (mm x mm)	Size Code					
			Vertical Timber <sup>2</sup>	Horizontal Timber <sup>2</sup>	Kingsbury <sup>3</sup>	Seymour <sup>3</sup>	Tudor <sup>3</sup>
1780 x 1806	1930 x 1891	6060	4484	4573	4999	4255	4255
1934 x 1806	2084 x 1891	6660	4540	4634	4999	4312	4312
1934 x 1907	2084 x 1991	6664	4540	4634	4999	4312	4312
1934 x 1957	2084 x 2041	6666	4582	4677	5014	4355	4355
1934 x 2112	2084 x 2196	6670	4582	4677	5072	4355	4355
2084 x 1806	2234 x 1891	7060	4656	4748	5072	4427	4427
2084 x 1907	2234 x 1991	7064	4671	4763	5107	4442	4442
2084 x 1957	2234 x 2041	7066	4687	4777	5167	4453	4453
2084 x 2112	2234 x 2196	7070	4687	4777	5197	4453	4453
2209 x 1907	2359 x 1991	7564	4725	4822	5353	4504	4504
2209 x 1957	2359 x 2041	7566	4738	4837	5385	4515	4515
2209 x 2112	2359 x 2196	7570	4768	4858	5482	4540	4540
2234 x 1907	2384 x 1991	7664	4725	4822	5370	4504	4504
2234 x 1957	2384 x 2041	7666	4738	4837	5436	4515	4515
2234 x 2112	2384 x 2196	7670	4768	4859	5542	4540	4540
2389 x 1907	2539 x 1991	8064	4912	5005	5854	4687	4687
2389 x 1957	2539 x 2041	8066	4924	5020	5883	4700	4700
2389 x 2112	2539 x 2196	8070	4943	5029	6038	4711	4711

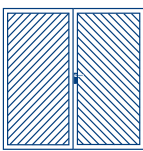
**Timber door - standard sizes**

Nominal Door Size Width x Height (mm x mm)	Overall frame size (between fix) <sup>1</sup> Width x Height (mm x mm)	Size Code			
			Chevron Timber <sup>3</sup>	Ashton <sup>3,4</sup>	Ashton Chevron <sup>3,4</sup>
1780 x 1806	1930 x 1891	6060	4999	5370	5610
1934 x 1806	2084 x 1891	6660	4999	5370	5610
1934 x 1907	2084 x 1991	6664	4999	5370	5610
1934 x 1957	2084 x 2041	6666	5014	5385	5620
1934 x 2112	2084 x 2196	6670	5072	5436	5682
2084 x 1806	2234 x 1891	7060	5072	5436	5682
2084 x 1907	2234 x 1991	7064	5107	5482	5724
2084 x 1957	2234 x 2041	7066	5167	5542	5780
2084 x 2112	2234 x 2196	7070	5197	5565	5811
2209 x 1907	2359 x 1991	7564	5353	5724	5964
2209 x 1957	2359 x 2041	7566	5385	5750	5997
2209 x 2112	2359 x 2196	7570	5482	5854	6096
2234 x 1907	2384 x 1991	7664	5370	5737	5982
2234 x 1957	2384 x 2041	7666	5436	5811	6051
2234 x 2112	2384 x 2196	7670	5542	5905	6155
2389 x 1907	2539 x 1991	8064	5854	6222	6467
2389 x 1957	2539 x 2041	8066	5883	5763	6498
2389 x 2112	2539 x 2196	8070	6038	6408	6649

<sup>1</sup> No fitting clearance allowed.

<sup>2</sup> The above doors are shown as 50/50 door leaves configuration. Up to 2234 mm overall frame width these doors are also available as a 1/3 2/3 door configuration on Vertical Timber and Horizontal Timber doors.

Prices are the same but please be aware panel configurations may be different from those shown above (1/3 2/3 is a term used to describe these doors but please note the 1/3 door leaf is always 800 mm wide with the 2/3 element varying to make the desired overall width). 1/3 leaf is always leading.

<sup>3</sup> Not available in 70/30 configuration. Only Vertical Timber and Horizontal Timber Side Hinged doors are available in 70/30 configuration up to 7'0" wide.

<sup>4</sup> On doors with windows, please state on order if plain or crystal panes.

### Timber door - purpose-made sizes

Overall frame size  
(between fix)<sup>1</sup>  
Width x Height  
(mm x mm)

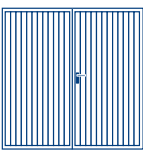
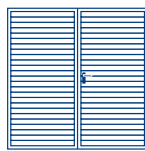
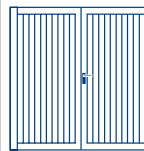
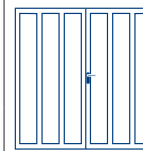
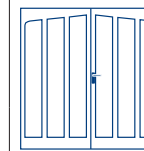

	 Vertical Timber <sup>2</sup>	 Horizontal Timber <sup>2</sup>	 Kingsbury <sup>3</sup>	 Seymour <sup>3</sup>	 Tudor <sup>3</sup>
1930 - 2233 x 1891 - 2041	4766	4859	5255	4556	4556
1930 - 2233 x 2042 - 2196	4859	4956	5352	4651	4651
2234 - 2384 x 1891 - 2041	4952	5051	5451	4749	4749
2234 - 2384 x 2042 - 2196	5085	5180	5827	4878	4878
2385 - 2539 x 1891 - 2041	5352	5451	6105	5144	5144
2385 - 2539 x 2042 - 2196	5434	5537	6204	5224	5224

<sup>1</sup> No fitting clearance allowed.

<sup>2</sup> On doors with windows, please state on order if plain or crystal panes.

### Timber door - purpose-made sizes

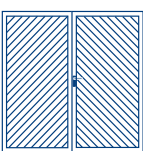
Overall frame size  
(between fix)<sup>1</sup>  
Width x Height  
(mm x mm)

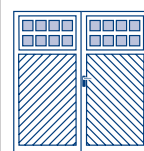
	 Chevron Timber <sup>3</sup>	 Ashton <sup>3,4</sup>	 Ashton Chevron <sup>3,4</sup>
1930 - 2233 x 1891 - 2041	5255	5616	5855
1930 - 2233 x 2042 - 2196	5352	5719	5953
2234 - 2384 x 1891 - 2041	5451	5813	6051
2234 - 2384 x 2042 - 2196	5827	6210	7579
2385 - 2539 x 1891 - 2041	6105	6489	6740
2385 - 2539 x 2042 - 2196	6204	6576	6829

<sup>1</sup> No fitting clearance allowed.

<sup>2</sup> The above doors are shown as 50/50 door leaves configuration. Up to 2234 mm overall frame width these doors are also available as a 1/3 2/3 door configuration on Vertical Timber and Horizontal Timber doors.

Prices are the same but please be aware panel configurations may be different from those shown above (1/3 2/3 is a term used to describe these doors but please note the 1/3 door leaf is always 800 mm wide with the 2/3 element varying to make the desired overall width). 1/3 leaf is always leading.

<sup>3</sup> Not available in 70/30 configuration. Only Vertical Timber and Horizontal Timber Side Hinged doors are available in 70/30 configuration up to 7'0" wide.

<sup>4</sup> On doors with windows, please state on order if plain or crystal panes.

Options	Steel		Timber	
	Garage side doors add	Side-hinged doors add	Garage side doors add	Side-hinged doors add
For powder-coated steel doors <sup>1</sup> : - Moss Green (RAL 6005) - Ruby Red (RAL 3003) - Signal Blue (RAL 5005) - Jet Black (RAL 9005) - Steel Blue (RAL 5011) - Light Ivory (RAL 1015) - Pigeon Blue (RAL 5014) - Fir Green (RAL 6009) - Anthracite Grey (RAL 7016) - Stone Grey (RAL 7030) - Light Grey (RAL 7035) - Slate Grey (RAL 7015) - Agate Grey (RAL 7038) - Window Grey (RAL 7040) - Chartwell Green (BS 4800) - Burgundy Brown - Golden Brown - Terra Brown (RAL 8028)	140	182	-	-
Colour matched windows for Salisbury side-hinged doors <sup>2</sup>	-	228	-	-
Black window panes for Salisbury doors (price per door)	-	52	-	-
Coloured window frames to match door colour – Beaumont doors (price per window). Beaumont doors up to 2539 mm wide = 4 windows <sup>3</sup> .	67 each	67 each	-	-
Handles for steel and timber doors: - knob/lever black plastic	46	46	46	46
For timber doors: factory fully finished in - Light Oak - Antique Oak - Mahogany - Walnut - Chestnut - Ebony	-	-	194	294
Factory white primer ready for on-site painting	-	-	294	361
Factory fully finished painting (any RAL colour)	-	-	486	603
Anodised Aluminium lever/lever handles: - white	171	171	171	171
Anodised Aluminium lever/lever handles: - chrome effect	214	214	214	214
Left hand leading	125	125	125	125
Fitting compensation kit (part no. 8261)	190	190	190	190
Poly-wrapping	49	49	-	-

<sup>1</sup> Coloured Beaumont with windows doors are supplied with white window frames as standard.

<sup>2</sup> Only available on steel side-hinged doors.

<sup>3</sup> Colour match windows not available in Burgundy Brown or Golden Brown.

Chassis and frame will be Terra Brown (RAL 8028) except when the door is ebony when chassis/frame will be black (RAL 9005) or the door is white and the chassis/frame will be RAL 9016. To select an alternative colour chassis/frame from the options there is a charge of £ 182.

# Garage Side Doors & Side-hinged Doors – Specifications

Door leaves supplied factory pre-framed ready for site installation. Fixed leaf (RH side when viewed from inside) fitted with tower bolts at top and bottom of inner leading edge. The floor will need to be finished and level for the bottom tower bolts to engage. These doors are designed for in-between fixing.

## Garage Side door factory pre-framed

Between brickwork fixing

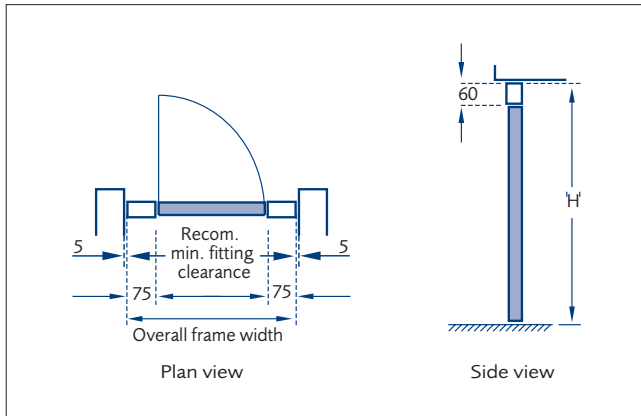

Door specification

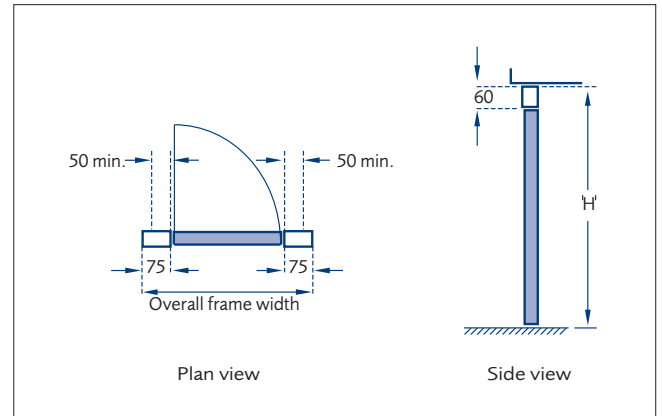

The nominal clear passage clearance is 74 mm less than the opening width and 125 mm less than the opening height. **Not recommended** for behind brickwork fixing.

## Side-hinged door factory pre-framed

Between brickwork fixing

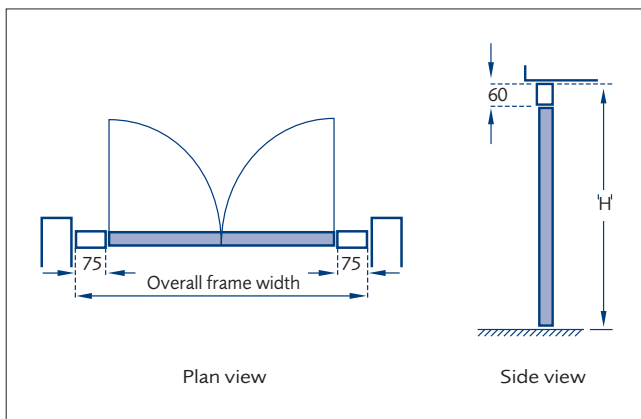

Door specification

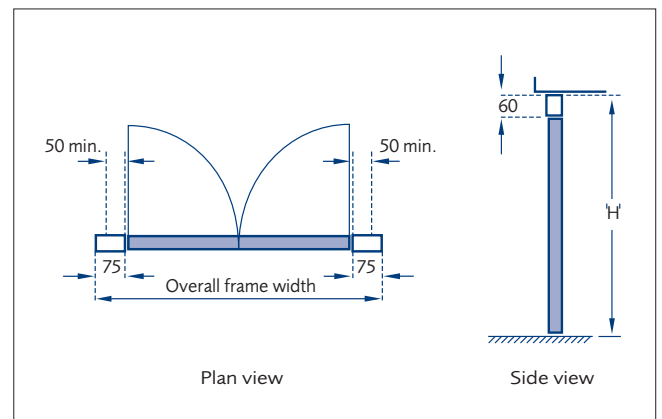

The nominal drive through clearance is 30 mm less than the opening width and 125 mm less than the opening height. **Not recommended** for behind brickwork fixing.

## Side-Hinged Garage Door Steel Frame Specifications

	Width	Height	Depth
Side-Hinged Doors	75 mm	60 mm	75 mm

# Steel Panel Doors – Specifications

## Canopy Gear Specifications

The canopy gear allows the door to travel in vertical tracks and is counterbalanced by an overhead torsion spring. The nominal drive through is 40 mm less than the opening width and 130 mm less than the opening height.

In the open position, the door projects approximately one third of the door height, forming a canopy.

For doors fitted with an operator, please observe operator specifications.

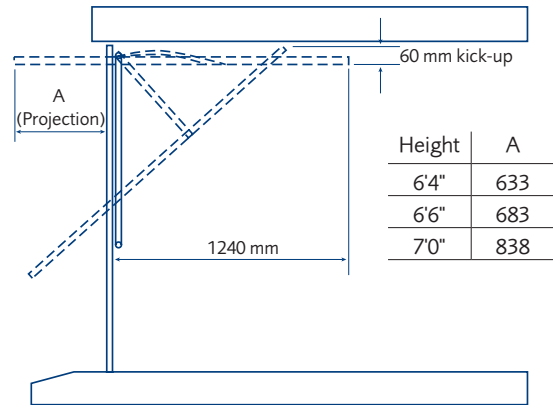

### On-site timber frame

#### Behind brickwork fixing

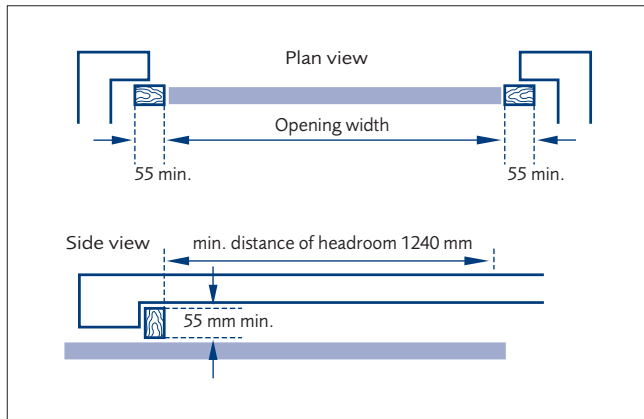

#### Between brickwork fixing

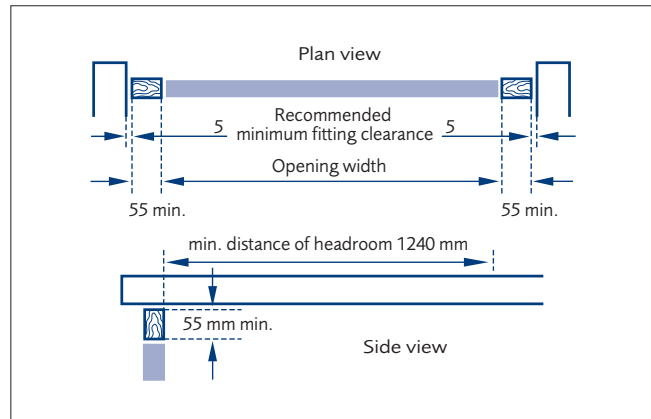

### Factory pre-framed with steel box frame

The garage door is supplied factory fitted to a steel box section frame and is secured to the brickwork by using just 7 fixings.

#### Behind brickwork fixing

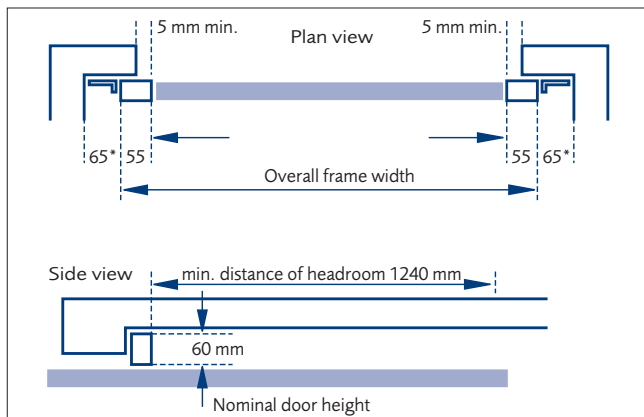

\* width of anchor brackets in this position

#### Between brickwork fixing

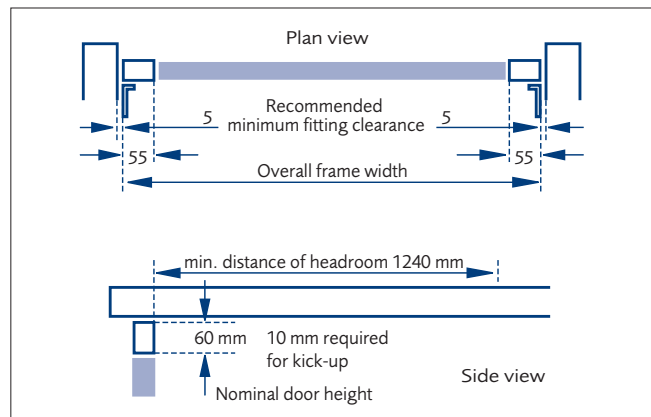

### Up & Over Garage Door Steel Frame Dimensions

	Width	Depth
Canopy steel frame (single door)	60 mm	40 mm
Retractable steel frame (single door)	75 mm	40 mm
Retractable steel frame (double door)	75 mm	80 mm

### Single & Double Retractable Gear Specifications

The retractable gear allows the door to be retracted inside the garage when open by means of horizontal overhead tracks supported by wall or ceiling mounted suspension brackets. This gear is available as an option for single doors and comes as standard with double garage doors.

The nominal drive through clearance is 105 mm less than the opening width and 110 mm less than the opening height for single doors and 140 mm less than the opening height for double doors.

For doors fitted with an operator, please observe operator specifications.

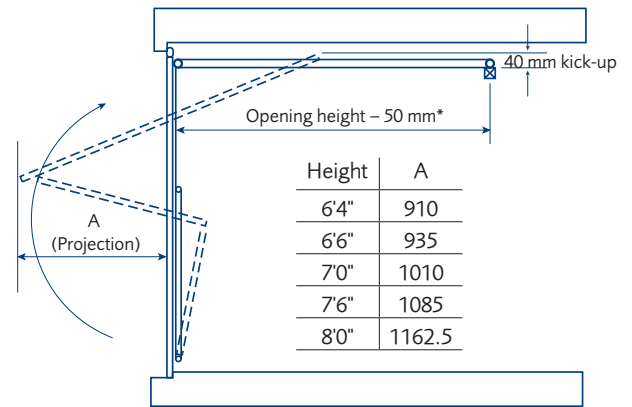

\* Only applies to single doors up to 1070.

### On-site timber frame

#### Behind brickwork fixing

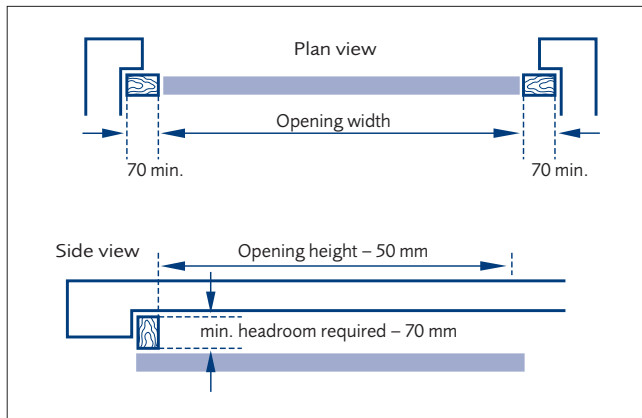

#### Between brickwork fixing

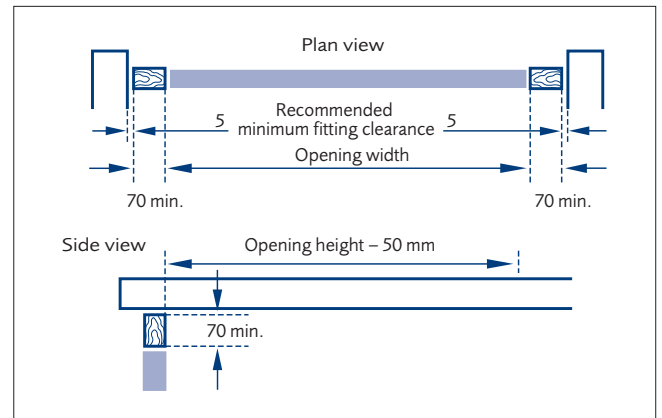

### Factory pre-framed with steel box frame

The garage door is supplied factory fitted to a steel box section frame and is secured to the brickwork by using just 7 fixings.

#### Behind brickwork fixing

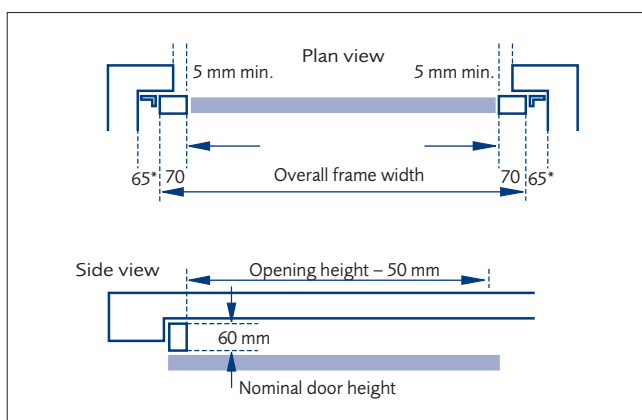

\* width of anchor brackets in this position

#### Between brickwork fixing

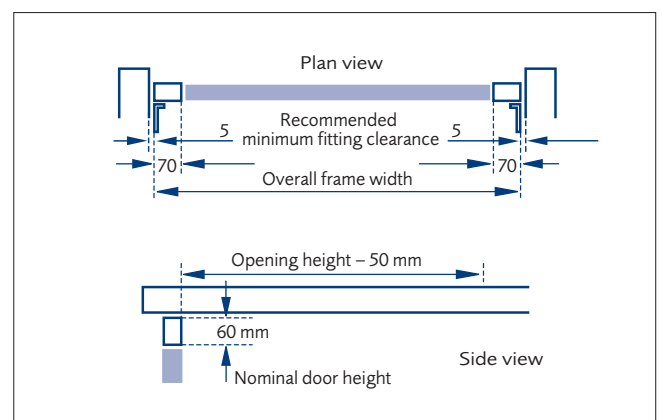

### Retractable Plus Gear

For any door up to a width of 2744 mm in any of the three standard heights Retractable Plus Gear is available. This gear type creates clear drive through width at the crucial wing mirror height.

Door height	Clear height below lifting arms
7'0"	1260
6'6"	1105
6'4"	1055



# Steel Sectional Garage Doors

## Door sections

Made of galvanised steel. Premium doors have a 42 mm thick insulated door section that is filled with PU-foam (100 % CFC-free). Bottom door section comes with floor seal.

## Surface

Outside: Woodgrain embossed, Slategrain or Silkgrain textures with painted or foil coated finishes.

Inside: pebble texture.

## Spring arrangement

All doors up to 4000 mm wide (excluding Silkgrain) come with tension springs as standard and torsion springs are available at extra cost. All doors over 4000 mm wide (excluding Silkgrain) come with torsion springs as standard. Low headroom application available at extra cost. Doors with a Silkgrain surface finish are supplied with tension springs as standard up to 3049 mm wide and torsion springs as standard on doors over 3050 mm wide.

## Side frames & Fascia

Sectional doors are designed to be fitted behind the reveals and side frames are supplied white in colour. Cover profiles are available for use with coloured or foil coated door finishes. A single skin fascia is supplied with all doors which is finished in the same colour as the door sections. For Slategrain models, the door section has a Slategrain texture but the cover profiles and fascia are smooth.

## Colours

Steel Woodgrain and Silkgrain doors can be ordered in almost any colour from the RAL colour chart. Slategrain is only available in standard RAL colours and Traffic White (RAL 9016).

Standard colours are:

- |                          |                              |                              |                              |
|--------------------------|------------------------------|------------------------------|------------------------------|
| - Light Ivory (RAL 1015) | - Anthracite Grey (RAL 7016) | - Quartz Grey (RAL 7039)     | - Grey Aluminium (RAL 9007)  |
| - Moss Green (RAL 6005)  | - Titan Metallic (CH 703)    | - Window Grey (RAL 7040)     | - Chartwell Green (BS 14C35) |
| - Fir Green (RAL 6009)   | - Stone Grey (RAL 7030)      | - Terra Brown (RAL 8028)     |                              |
| - Basalt Grey (RAL 7012) | - Light Grey (RAL 7035)      | - Jet Black (RAL 9005)       |                              |
| - Slate Grey (RAL 7015)  | - Agate Grey (RAL 7038)      | - White Aluminium (RAL 9006) |                              |

Special RAL colours are:

- |                         |                          |                             |                            |
|-------------------------|--------------------------|-----------------------------|----------------------------|
| - Black Red (RAL 3007)  | - Black Grey (RAL 7021)  | - Signal Black (RAL 9004)   | - Traffic Black (RAL 9017) |
| - Black Blue (RAL 5004) | - Black Brown (RAL 8022) | - Graphite Black (RAL 9011) |                            |

Non standard RAL colours are:

Based on full RAL colour chart excluding Traffic Purple (RAL 4006), Purple Violet (RAL 4007), Tar Black (RAL 9021) and pearlescent or florescent options.

Timber effect foil coated doors are available in the following five finishes:

Golden Oak, Dark Oak, Night Oak, Rosewood and Winchester Oak. Only Golden Oak and Rosewood surface finishes are kept as stock door sizes (prices highlighted in bold) for timber effect sectional garage doors. Dark Oak, Night Oak and Winchester Oak surface finishes are not stocked, but are made to order.

Foil coated finish also available in Titan Metallic (CH 703)

## Handle

Sectional doors in shaded boxes are generally supplied ex-works for automatic operation, i.e. without handle hole and lock. Factory-fitted handle and lock are available with an increased lead-time. All other doors are on a 4 to 6 week lead-time. For electrical operation of a garage with no other personal access, an emergency release kit must be fitted.

## Packaging

Sectional doors are provided in a palletted format shrink wrapped for easy handling.

## Stock availability

Popular sectional doors are generally ex-stock in Traffic White (RAL 9016) and Terra Brown (RAL 8028) in some sizes, other sizes and colour options require up to 6 weeks lead-time. Contact sales office for further details.

## Gears

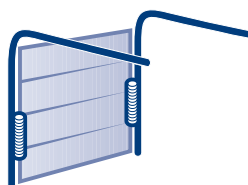

Tension spring

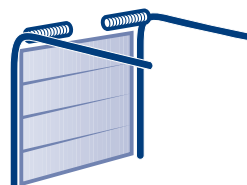

Torsion spring

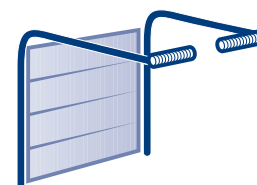

Low headroom torsion spring fitting



## Window options

### Georgian design

Prices £ stated per window  
Window frames white as standard

Standard	Cross	Diamond	
Premium - Woodgrain <sup>1</sup>	153	189	189
Premium - Timber effect <sup>2</sup>	194	230	230

### Linear small design

Prices £ stated per window  
Window frames white as standard

Linear 1	
Premium - Woodgrain <sup>1</sup>	153

### Linear medium design

Prices £ stated per window  
Window frames white as standard

Standard	Cross	Diamond	Linear 1	Linear 2	
Premium - Woodgrain, Silkgrain <sup>1</sup> , Slategrain	153	189	189	153	186
Premium - Timber effect <sup>2</sup>	194	230	230	194	227

### Linear large design

Prices £ stated per window  
Window frames white as standard

Standard	Cross	Diamond	Linear 1	Linear 2	Linear 3	
Premium - Silkgrain, Slategrain	153	189	189	153	186	240
Premium - Timber effect <sup>2</sup>	194	230	230	194	227	271

<sup>1</sup> Colours available at surcharge per window (£ 42 for standard colour, £ 71 for non standard colour, £ 142 for special RAL colour).

<sup>2</sup> Window frames are painted in a colour to best complement the colour of the foil coat (colour incl. in price).

Please note, window frames are painted in a colour to complement the colour of the sectional garage door.

### Linear, Medium or Large (overall frame dimension: 395 mm x 270 mm)

Door widths from 2000 mm to 2125 mm wide have 3 windows, 2126 mm to 2750 mm wide have 4 windows, 2751 mm to 3500 mm wide have 5 windows, 3501 mm to 4000 mm wide have 6 windows, 4001 mm to 4750 mm wide have 7 windows and doors of 4751 mm up to 5500 mm wide have 8 windows.

### For Georgian doors

Door widths up to 2125 mm wide have 3 windows, 2126 mm to 2750 mm wide have 4 windows, 2751 mm to 3500 mm wide have 5 windows, 3501 mm to 4000 mm wide have 6 windows, 4001 mm to 4750 mm wide have 7 windows and doors of 4751 mm to 5500 mm wide have 8 windows.

### Linear 1 (overall frame dimension: 680 mm x 210 mm)

Door widths from 2000 mm to 2500 mm wide have 2 windows, 2501 mm to 3500 mm wide have 3 windows, 3501 mm to 4500 mm wide have 4 windows and doors of 4500 mm to 5500 mm wide have 5 windows.

### Linear 2 (overall frame dimension: 620 mm x 270 mm)

Doors widths from 2000 mm to 2240 mm wide have 2 windows, 2241 mm to 2970 mm wide have 3 windows, 2971 mm to 3690 mm wide have 4 windows, 3691 mm to 4420 mm wide have 5 windows, 4421 mm to 5140 mm wide have 6 windows and doors of 5141 mm to 5500 mm wide have 7 windows.

### Linear 3 (overall frame dimension: 1004 mm x 270 mm)

Door widths from 2250 mm to 3400 mm wide have 2 windows, 3401 mm to 4490 mm wide have 3 windows and doors of 4491 mm to 5500 mm wide have 4 windows.

Please state on order if clear or crystal panes. Georgian sectional doors under 7 ft wide only have 3 pressings.

### Secured by Design – Free optional upgrade available after installation

The following criteria must be met to be eligible for Secured by Design accreditation:

- Premium 42 mm sectional door (without windows).
- Fitted behind the opening.
- Automated with a GaraMatic operator (sold separately).
- Door must be fitted to SBD standard, unmodified and registered with Garador.



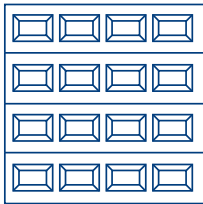
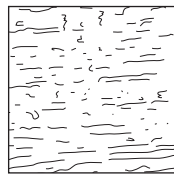

**Georgian design**

Woodgrain

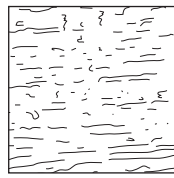
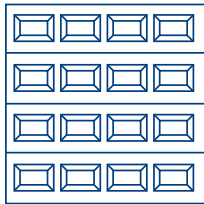

Premium

Brickwork opening Width x Height (mm x mm)	Size Code		Surcharge for Standard Colours	Surcharge for Non-Std. Colours	Surcharge for Special RAL
2080 x 2000	I 61066	<b>1816</b>	246	402	782
2080 x 2080	I 610610	<b>1837</b>	256	418	813
2134 x 2000	I 7066	<b>1878</b>	253	411	802
2134 x 2125	I 7070	<b>1902</b>	268	437	852
2250 x 1900	M 7462	1931	250	407	792
2250 x 2000	M 7466	1986	266	434	845
2250 x 2125	M 7470	1989	283	461	899
2286 x 2000	I 7666	<b>1878</b>	270	441	860
2286 x 2125	I 7670	<b>1902</b>	288	468	912
2286 x 2250	I 7674	1897	303	496	967
2286 x 2375	I 7679	2027	320	523	1020
2286 x 2500	I 7682	2022	337	552	1074
2375 x 1900	M 7962	1931	263	430	837
2375 x 2000	M 7966	1933	281	459	894
2375 x 2125	M 7970	1938	297	486	949
2375 x 2250	M 7974	2021	316	514	1004
2438 x 2000	I 8066	1982	289	469	916
2438 x 2125	I 8070	<b>2013</b>	306	499	973
2438 x 2250	I 8074	2000	324	528	1030
2438 x 2375	I 8079	2132	342	558	1087
2438 x 2500	I 8082	2126	360	588	1145
2500 x 1900	M 8262	1931	278	451	880
2500 x 2000	M 8266	1933	295	482	939
2500 x 2125	M 8270	1938	314	512	998
2500 x 2250	M 8274	2021	332	541	1057
2500 x 2375	M 8279	2119	351	572	1116
2500 x 2500	M 8282	2124	369	601	1175
2500 x 2750	M 8290	2300	406	662	1291
2591 x 2000	I 8666	1982	306	499	973
2591 x 2125	I 8670	2013	325	531	1034
2625 x 2125	M 8770	2098	329	537	1048
2740 x 2000	I 9066	2158	324	528	1029
2740 x 2125	I 9070	2188	345	561	1094
2750 x 2000	M 9166	2341	325	531	1033
2750 x 2125	M 9170	2385	346	563	1098
2750 x 2250	M 9174	2474	365	596	1162
2750 x 2375	M 9179	2493	386	629	1227
2750 x 2500	M 9182	2577	406	662	1291
2896 x 2000	I 9666	2265	342	558	1087
2896 x 2125	I 9670	2309	363	593	1156
3000 x 2000	M 91066	2459	354	577	1126
3000 x 2125	M 91070	2457	376	614	1197
3000 x 2250	M 91074	2534	399	650	1268
3000 x 2375	M 91079	2580	421	686	1337
3000 x 2500	M 91082	2664	442	723	1409
3000 x 3000	M 910910	3463	531	866	1690
3048 x 2000	I 1066	2174	360	588	1145
3048 x 2125	I 1070	2219	383	625	1216
3250 x 2000	M 10866	2553	384	627	1221
3250 x 2125	M 10870	2622	407	665	1296
3250 x 2250	M 10874	2705	431	705	1373
3353 x 2000	I 1166	2598	395	646	1259
3353 x 2125	I 1170	2643	421	686	1337
3500 x 2000	M 11666	2780	412	674	1315



Woodgrain

Georgian design

Brickwork opening  
Width x Height  
(mm x mm)

Size Code



Premium

Surcharge for Standard Colours

Surcharge for Non-Std. Colours

Surcharge for Special RAL

Brickwork opening Width x Height (mm x mm)	Size Code		Surcharge for Standard Colours	Surcharge for Non-Std. Colours	Surcharge for Special RAL	
3500 x 2125	<b>M</b>	11670	2853	439	715	1397
3500 x 2250	<b>M</b>	11674	2943	465	758	1479
3658 x 2000	<b>I</b>	1266	3065	431	705	1373
3658 x 2125	<b>I</b>	1270	3114	459	748	1459
3750 x 2000	<b>M</b>	12466	3002	442	723	1409
3750 x 2125	<b>M</b>	12470	3080	469	767	1497
3750 x 2250	<b>M</b>	12474	3177	498	812	1586
3962 x 2000	<b>I</b>	1366	3187	467	764	1487
3962 x 2125	<b>I</b>	1370	3232	497	810	1581
4000 x 2000	<b>M</b>	13266	3214	471	770	1502
4000 x 2125	<b>M</b>	13270	3295	501	818	1596
4000 x 2250	<b>M</b>	13274	3401	531	866	1690
4250 x 2000	<b>M</b>	131166	3315	501	818	1596
4250 x 2125	<b>M</b>	131170	3406	533	870	1695
4250 x 2250	<b>M</b>	131174	3510	563	920	1795
4267 x 2000	<b>I</b>	1466	<b>3314</b>	503	820	1603
4267 x 2125	<b>I</b>	1470	<b>3367</b>	535	873	1702
4420 x 2000	<b>I</b>	14666	3433	522	850	1660
4420 x 2125	<b>I</b>	14670	<b>3491</b>	554	903	1763
4500 x 2000	<b>M</b>	14966	3406	531	866	1690
4500 x 2125	<b>M</b>	14970	3509	563	920	1795
4500 x 2250	<b>M</b>	14974	3620	597	974	1901
4572 x 2000	<b>I</b>	1566	<b>3497</b>	538	879	1718
4572 x 2125	<b>I</b>	1570	3554	572	935	1824
4725 x 2000	<b>I</b>	15666	3669	557	909	1775
4725 x 2125	<b>I</b>	15670	<b>3726</b>	592	966	1885
4750 x 2000	<b>M</b>	15766	3510	560	914	1783
4750 x 2125	<b>M</b>	15770	3613	595	971	1896
4750 x 2250	<b>M</b>	15774	3722	630	1027	2006
4877 x 2000	<b>I</b>	1666	<b>3669</b>	574	938	1832
4877 x 2125	<b>I</b>	1670	3726	611	997	1945
5000 x 2000	<b>M</b>	16566	3608	590	961	1877
5000 x 2125	<b>M</b>	16570	3691	627	1022	1995
5000 x 2250	<b>M</b>	16574	3807	663	1082	2113
5000 x 2375	<b>M</b>	16579	3947	700	1142	2229
5000 x 2500	<b>M</b>	16582	3936	736	1203	2346
5500 x 2000	<b>M</b>	18166	3902	648	1058	2065
5500 x 2125	<b>M</b>	18170	4071	689	1123	2193
5500 x 2250	<b>M</b>	18174	4306	729	1191	2323

Prices in bold are generally a stock item. Non-bold prices require a longer lead-time.

Purpose-made sizes available upon request. Non standard colours also available upon request. Doors supplied without locking as standard (see options on page 66 for handles). For window options please see page 49.

**I** Imperial door sizes.

**M** Metric door sizes. Extended lead time of 4-6 weeks.

Supplied as standard with tension spring gear. Torsion spring fitting available for Premium doors at £ 111 surcharge.

Supplied as standard with torsion spring gear. Low headroom fitting available at £ 180 surcharge.

Purpose-made sizes available upon request. Non standard colours also available upon request. Doors supplied without locking as standard (see options on page 66 for handles). For window options please see page 49.

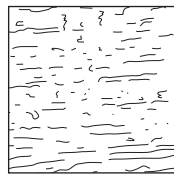
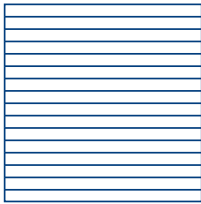

Woodgrain

**Linear small design**

 Brickwork opening  
Width x Height  
(mm x mm)

 Size  
Code



Premium

 Surcharge  
for  
Standard  
Colours

 Surcharge  
for  
Non-Std.  
Colours

 Surcharge  
for Special  
RAL

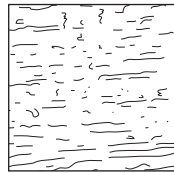
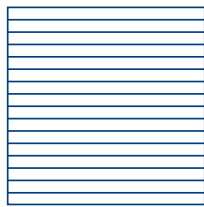
Brickwork opening Width x Height (mm x mm)	Size Code	Premium	Surcharge for Standard Colours	Surcharge for Non-Std. Colours	Surcharge for Special RAL	
2080 x 2000	I	61066	1435	246	402	782
2080 x 2080	I	610610	1488	256	418	813
2134 x 2000	I	7066	1487	253	411	802
2134 x 2125	I	7070	1537	268	437	852
2250 x 1900	M	7462	1571	250	407	792
2250 x 2000	M	7466	1620	266	434	845
2250 x 2125	M	7470	1623	283	461	899
2286 x 2000	I	7666	1487	270	441	860
2286 x 2125	I	7670	1537	288	468	912
2286 x 2250	I	7674	1559	303	496	967
2286 x 2375	I	7679	1680	320	523	1020
2286 x 2500	I	7682	1677	337	552	1074
2375 x 1900	M	7962	1571	263	430	837
2375 x 2000	M	7966	1573	281	459	894
2375 x 2125	M	7970	1573	297	486	949
2375 x 2250	M	7974	1604	316	514	1004
2438 x 2000	I	8066	1562	289	469	916
2438 x 2125	I	8070	1625	306	499	973
2438 x 2250	I	8074	1634	324	528	1030
2438 x 2375	I	8079	1761	342	558	1087
2438 x 2500	I	8082	1753	360	588	1145
2500 x 1900	M	8262	1571	278	451	880
2500 x 2000	M	8266	1573	295	482	939
2500 x 2125	M	8270	1573	314	512	998
2500 x 2250	M	8274	1604	332	541	1057
2500 x 2375	M	8279	1692	351	572	1116
2500 x 2500	M	8282	1695	369	601	1175
2500 x 2750	M	8290	2060	406	662	1291
2591 x 2000	I	8666	1562	306	499	973
2591 x 2125	I	8670	1625	325	531	1034
2625 x 2125	M	8770	1780	329	537	1048
2740 x 2000	I	9066	1693	324	528	1029
2740 x 2125	I	9070	1750	345	561	1094
2750 x 2000	M	9166	1806	325	531	1033
2750 x 2125	M	9170	1864	346	563	1098
2750 x 2250	M	9174	1874	365	596	1162
2750 x 2375	M	9179	1925	386	629	1227
2750 x 2500	M	9182	2009	406	662	1291
2896 x 2000	I	9666	1769	342	558	1087
2896 x 2125	I	9670	1841	363	593	1156
3000 x 2000	M	91066	2027	354	577	1126
3000 x 2125	M	91070	2025	376	614	1197
3000 x 2250	M	91074	2043	399	650	1268
3000 x 2375	M	91079	2097	421	686	1337
3000 x 2500	M	91082	2183	442	723	1409
3000 x 3000	M	910910	2648	531	866	1690
3048 x 2000	I	1066	1709	360	588	1145
3048 x 2125	I	1070	1771	383	625	1216
3250 x 2000	M	10866	2038	384	627	1221
3250 x 2125	M	10870	2097	407	665	1296
3250 x 2250	M	10874	2143	431	705	1373
3353 x 2000	I	1166	2015	395	646	1259
3353 x 2125	I	1170	2097	421	686	1337
3500 x 2000	M	11666	2177	412	674	1315



Woodgrain

Linear small design



Premium

Brickwork opening Width x Height (mm x mm)	Size Code			Surcharge for Standard Colours	Surcharge for Non-Std. Colours	Surcharge for Special RAL
3500 x 2125	<b>M</b>	11670	<b>2231</b>	439	715	1397
3500 x 2250	<b>M</b>	11674	<b>2279</b>	465	758	1479
3658 x 2000	<b>I</b>	1266	<b>2369</b>	431	705	1373
3658 x 2125	<b>I</b>	1270	<b>2462</b>	459	748	1459
3750 x 2000	<b>M</b>	12466	<b>2296</b>	442	723	1409
3750 x 2125	<b>M</b>	12470	<b>2364</b>	469	767	1497
3750 x 2250	<b>M</b>	12474	<b>2411</b>	498	812	1586
3962 x 2000	<b>I</b>	1366	<b>2458</b>	467	764	1487
3962 x 2125	<b>I</b>	1370	<b>2551</b>	497	810	1581
4000 x 2000	<b>M</b>	13266	<b>2420</b>	471	770	1502
4000 x 2125	<b>M</b>	13270	<b>2493</b>	501	818	1596
4000 x 2250	<b>M</b>	13274	<b>2546</b>	531	866	1690
4250 x 2000	<b>M</b>	131166	<b>2556</b>	501	818	1596
4250 x 2125	<b>M</b>	131170	<b>2631</b>	533	870	1695
4250 x 2250	<b>M</b>	131174	<b>2689</b>	563	920	1795
4267 x 2000	<b>I</b>	1466	<b>2550</b>	503	820	1603
4267 x 2125	<b>I</b>	1470	<b>2652</b>	535	873	1702
4420 x 2000	<b>I</b>	14666	<b>2635</b>	522	850	1660
4420 x 2125	<b>I</b>	14670	<b>2741</b>	554	903	1763
4500 x 2000	<b>M</b>	14966	<b>2687</b>	531	866	1690
4500 x 2125	<b>M</b>	14970	<b>2765</b>	563	920	1795
4500 x 2250	<b>M</b>	14974	<b>2820</b>	597	974	1901
4572 x 2000	<b>I</b>	1566	<b>2685</b>	538	879	1718
4572 x 2125	<b>I</b>	1570	<b>2790</b>	572	935	1824
4725 x 2000	<b>I</b>	15666	<b>2798</b>	557	909	1775
4725 x 2125	<b>I</b>	15670	<b>2908</b>	592	966	1885
4750 x 2000	<b>M</b>	15766	<b>2768</b>	560	914	1783
4750 x 2125	<b>M</b>	15770	<b>2848</b>	595	971	1896
4750 x 2250	<b>M</b>	15774	<b>2905</b>	630	1027	2006
4877 x 2000	<b>I</b>	1666	<b>2798</b>	574	938	1832
4877 x 2125	<b>I</b>	1670	<b>2908</b>	611	997	1945
5000 x 2000	<b>M</b>	16566	<b>2849</b>	590	961	1877
5000 x 2125	<b>M</b>	16570	<b>2908</b>	627	1022	1995
5000 x 2250	<b>M</b>	16574	<b>2966</b>	663	1082	2113
5000 x 2375	<b>M</b>	16579	<b>3028</b>	700	1142	2229
5000 x 2500	<b>M</b>	16582	<b>3088</b>	736	1203	2346
5500 x 2000	<b>M</b>	18166	<b>3048</b>	648	1058	2065
5500 x 2125	<b>M</b>	18170	<b>3132</b>	689	1123	2193
5500 x 2250	<b>M</b>	18174	<b>3211</b>	729	1191	2323

Prices in bold are generally a stock item. Non-bold prices require a longer lead-time.

- I** Imperial door sizes.
- M** Metric door sizes. Extended lead time of 4-6 weeks.
- Supplied as standard with tension spring gear. Torsion spring fitting available for Premium doors at £ 111 surcharge.
- Supplied as standard with torsion spring gear. Low headroom fitting available at £ 180 surcharge.

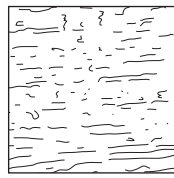

Woodgrain

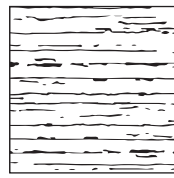

Slategrain

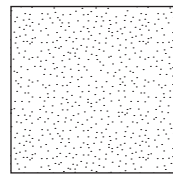
 Silkgrain<sup>1</sup>
**Linear medium design**

 Brickwork  
opening  
Width x Height  
(mm x mm)

 Size  
Code

Premium



Premium



Premium





 Surcharge  
for  
Standard  
Colours

 Surcharge  
for  
Non-Std.  
Colours

 Surcharge  
for Special  
RAL

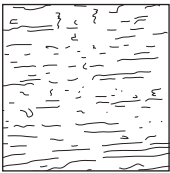
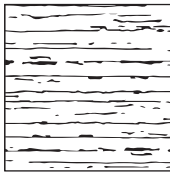
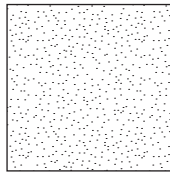
Brickwork opening Width x Height (mm x mm)	Size Code	Premium	Premium	Premium	Surcharge for Standard Colours	Surcharge for Non-Std. Colours	Surcharge for Special RAL
2080 x 2000	I 61066	<b>1435</b>	1435	1764	246	402	782
2080 x 2080	I 610610	<b>1488</b>	1488	1834	256	418	813
2134 x 2000	I 7066	<b>1487</b>	1487	1764	253	411	802
2134 x 2125	I 7070	<b>1537</b>	1537	<b>1834</b>	268	437	852
2250 x 1900	M 7462	1537	1571	1881	250	407	792
2250 x 2000	M 7466	1620	1620	1917	266	434	845
2250 x 2125	M 7470	1623	1623	1921	283	461	899
2286 x 2000	I 7666	<b>1487</b>	1487	<b>1764</b>	270	441	860
2286 x 2125	I 7670	<b>1537</b>	1537	<b>1834</b>	288	468	912
2286 x 2250	I 7674	<b>1559</b>	1559	1918	303	496	967
2286 x 2375	I 7679	<b>1680</b>	1680	2003	320	523	1020
2286 x 2500	I 7682	1677	1677	2082	337	552	1074
2375 x 1900	M 7962	1571	1571	1881	263	430	837
2375 x 2000	M 7966	1573	1573	1886	281	459	894
2375 x 2125	M 7970	1573	1573	1892	297	486	949
2375 x 2250	M 7974	1604	1604	1962	316	514	1004
2438 x 2000	I 8066	<b>1562</b>	1562	1870	289	469	916
2438 x 2125	I 8070	<b>1625</b>	1625	<b>1947</b>	306	499	973
2438 x 2250	I 8074	<b>1634</b>	1634	2004	324	528	1030
2438 x 2375	I 8079	1761	1761	2099	342	558	1087
2438 x 2500	I 8082	1753	1753	2196	360	588	1145
2500 x 1900	M 8262	1571	1571	1881	278	451	880
2500 x 2000	M 8266	1573	1573	1886	295	482	939
2500 x 2125	M 8270	1573	1573	1892	314	512	998
2500 x 2250	M 8274	1604	1604	1962	332	541	1057
2500 x 2375	M 8279	1692	1692	2086	351	572	1116
2500 x 2500	M 8282	1695	1695	2084	369	601	1175
2500 x 2750	M 8290	2060	2060	-	406	662	1291
2591 x 2000	I 8666	<b>1562</b>	1562	1870	306	499	973
2591 x 2125	I 8670	<b>1625</b>	1625	1947	325	531	1034
2625 x 2125	M 8770	1780	1780	2162	329	537	1048
2740 x 2000	I 9066	1693	1693	2049	324	528	1029
2740 x 2125	I 9070	<b>1750</b>	1750	2127	345	561	1094
2750 x 2000	M 9166	1806	1806	2125	325	531	1033
2750 x 2125	M 9170	1864	1864	2210	346	563	1098
2750 x 2250	M 9174	1874	1874	2259	365	596	1162
2750 x 2375	M 9179	1925	1925	2334	386	629	1227
2750 x 2500	M 9182	2009	2009	2441	406	662	1291
2896 x 2000	I 9666	1769	1769	2157	342	558	1087
2896 x 2125	I 9670	<b>1841</b>	1841	2241	363	593	1156
3000 x 2000	M 91066	2027	2027	2422	354	577	1126
3000 x 2125	M 91070	2025	2025	2424	376	614	1197
3000 x 2250	M 91074	2043	2043	2449	399	650	1268
3000 x 2375	M 91079	2097	2097	2559	421	686	1337
3000 x 2500	M 91082	2183	2183	2670	442	723	1409
3000 x 3000	M 910910	2649	2649	3233	531	866	1690
3048 x 2000	I 1066	1709	1709	2157	360	588	1145
3048 x 2125	I 1070	<b>1771</b>	1771	2241	383	625	1216
3250 x 2000	M 10866	2038	2038	2566	384	627	1221
3250 x 2125	M 10870	2097	2097	2639	407	665	1296
3250 x 2250	M 10874	2143	2143	2710	431	705	1373
3353 x 2000	I 1166	<b>2015</b>	2015	2579	395	646	1259
3353 x 2125	I 1170	<b>2097</b>	2097	2684	421	686	1337
3500 x 2000	M 11666	2177	2177	2727	412	674	1315
3500 x 2125	M 11670	2231	2231	2800	439	715	1397
3500 x 2250	M 11674	2279	2279	2884	465	758	1479



							
		Woodgrain	Slategrain	Silkgrain <sup>1</sup>			
Linear medium design					Surcharge for Standard Colours	Surcharge for Non-Std. Colours	Surcharge for Special RAL
Brickwork opening Width x Height (mm x mm)	Size Code	Premium	Premium	Premium			
3658 x 2000	<b>I</b> 1266	2369	2369	2910	431	705	1373
3658 x 2125	<b>I</b> 1270	<b>2462</b>	2462	3025	459	748	1459
3750 x 2000	<b>M</b> 12466	2296	2296	2790	442	723	1409
3750 x 2125	<b>M</b> 12470	2364	2364	2878	469	767	1497
3750 x 2250	<b>M</b> 12474	2411	2411	2967	498	812	1586
3962 x 2000	<b>I</b> 1366	<b>2458</b>	2458	3001	467	764	1487
3962 x 2125	<b>I</b> 1370	<b>2551</b>	2551	3114	497	810	1581
4000 x 2000	<b>M</b> 13266	2420	2420	2935	471	770	1502
4000 x 2125	<b>M</b> 13270	2493	2493	3008	501	818	1596
4000 x 2250	<b>M</b> 13274	2546	2546	3106	531	866	1690
4250 x 2000	<b>M</b> 131166	2556	2556	3060	501	818	1596
4250 x 2125	<b>M</b> 131170	2631	2631	3155	533	870	1695
4250 x 2250	<b>M</b> 131174	2689	2689	3247	563	920	1795
4267 x 2000	<b>I</b> 1466	<b>2550</b>	2550	3087	503	820	1603
4267 x 2125	<b>I</b> 1470	<b>2652</b>	2652	<b>3214</b>	535	873	1702
4420 x 2000	<b>I</b> 14666	<b>2635</b>	2635	3168	522	850	1660
4420 x 2125	<b>I</b> 14670	<b>2741</b>	2741	3296	554	903	1763
4500 x 2000	<b>M</b> 14966	2687	2687	3217	531	866	1690
4500 x 2125	<b>M</b> 14970	2765	2765	3317	563	920	1795
4500 x 2250	<b>M</b> 14974	2820	2820	3390	597	974	1901
4572 x 2000	<b>I</b> 1566	2685	2685	3190	538	879	1718
4572 x 2125	<b>I</b> 1570	2790	2790	3328	572	935	1824
4725 x 2000	<b>I</b> 15666	2798	2798	3255	557	909	1775
4725 x 2125	<b>I</b> 15670	<b>2908</b>	2908	3380	592	966	1885
4750 x 2000	<b>M</b> 15766	2768	2768	3283	560	914	1783
4750 x 2125	<b>M</b> 15770	2848	2848	3390	595	971	1896
4750 x 2250	<b>M</b> 15774	2905	2905	3485	630	1027	2006
4877 x 2000	<b>I</b> 1666	2798	2798	3311	574	938	1832
4877 x 2125	<b>I</b> 1670	<b>2908</b>	2908	3445	611	997	1945
5000 x 2000	<b>M</b> 16566	2849	2849	3411	590	961	1877
5000 x 2125	<b>M</b> 16570	2908	2908	3501	627	1022	1995
5000 x 2250	<b>M</b> 16574	2966	2966	3593	663	1082	2113
5000 x 2375	<b>M</b> 16579	3028	3028	3685	700	1142	2229
5000 x 2500	<b>M</b> 16582	3088	3088	3775	736	1203	2346
5500 x 2000	<b>M</b> 18166	3048	3048	3683	648	1058	2065
5500 x 2125	<b>M</b> 18170	3132	3132	3783	689	1123	2193
5500 x 2250	<b>M</b> 18174	3211	3211	3878	729	1191	2323

<sup>1</sup> Silkgrain surface supplied with tension spring gear up to 3048 mm wide.

Prices in bold are generally a stock item. Non-bold prices require a longer lead-time.

- I** Imperial door sizes.
- M** Metric door sizes. Extended lead time of 4-6 weeks.
- Supplied as standard with tension spring gear. Torsion spring fitting available for Premium doors at £ 111 surcharge.
- Supplied as standard with torsion spring gear. Low headroom fitting available at £ 180 surcharge.

Purpose-made sizes available upon request. Non standard colours also available upon request. Doors supplied without locking as standard (see options on page 66 for handles). For window options please see page 49.

For Slategrain models, the door section has a Slategrain texture but the cover profiles and fascia are smooth.

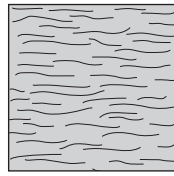
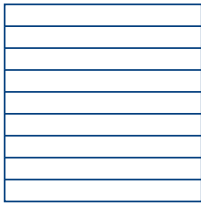
 Timber Effect /  
Titan (CH 703)

**Linear medium design**

 Brickwork  
opening  
Width x Height  
(mm x mm)

 Size  
Code

Premium

 Surcharge  
for  
Standard  
Colours

Brickwork opening Width x Height (mm x mm)	Size Code		Premium	Surcharge for Standard Colours
2080 x 2000	I	61066	1942	246
2080 x 2080	I	610610	2018 <sup>2</sup>	256
2134 x 2000	I	7066	1942 <sup>1</sup>	253
2134 x 2125	I	7070	2018 <sup>1</sup>	268
2250 x 1900	M	7462	2081	250
2250 x 2000	M	7466	2119	266
2250 x 2125	M	7470	2120	283
2286 x 2000	I	7666	1942 <sup>1</sup>	270
2286 x 2125	I	7670	2018 <sup>1</sup>	288
2286 x 2250	I	7674	2113 <sup>1</sup>	303
2286 x 2375	I	7679	2207	320
2286 x 2500	I	7682	2293	337
2375 x 1900	M	7962	2081	263
2375 x 2000	M	7966	2083	281
2375 x 2125	M	7970	2086	297
2375 x 2250	M	7974	2162	316
2438 x 2000	I	8066	2059 <sup>1</sup>	289
2438 x 2125	I	8070	2146 <sup>1</sup>	306
2438 x 2250	I	8074	2209 <sup>3</sup>	324
2438 x 2375	I	8079	2314	342
2438 x 2500	I	8082	2422	360
2500 x 1900	M	8262	2081	278
2500 x 2000	M	8266	2083	295
2500 x 2125	M	8270	2086	314
2500 x 2250	M	8274	2162	332
2500 x 2375	M	8279	2305	351
2500 x 2500	M	8282	2300	369
2500 x 2750	M	8290	-	406
2591 x 2000	I	8666	2059	306
2591 x 2125	I	8670	2146 <sup>1</sup>	325
2625 x 2125	M	8770	2395	329
2740 x 2000	I	9066	2264	324
2740 x 2125	I	9070	2352 <sup>1</sup>	345
2750 x 2000	M	9166	2355	325
2750 x 2125	M	9170	2448	346
2750 x 2250	M	9174	2502	365
2750 x 2375	M	9179	2586	386
2750 x 2500	M	9182	2703	406
2896 x 2000	I	9666	2386	342
2896 x 2125	I	9670	2480	363
3000 x 2000	M	91066	3209	354
3000 x 2125	M	91070	2690	376
3000 x 2250	M	91074	2719	399
3000 x 2375	M	91079	2841	421
3000 x 2500	M	91082	2966	442
3000 x 3000	M	910910	3594	531
3048 x 2000	I	1066	2386	360
3048 x 2125	I	1070	2480 <sup>3</sup>	383
3250 x 2000	M	10866	2854	384
3250 x 2125	M	10870	2936	407
3250 x 2250	M	10874	3017	431
3353 x 2000	I	1166	2863	395
3353 x 2125	I	1170	2979	421
3500 x 2000	M	11666	3038	412
3500 x 2125	M	11670	3119	439
3500 x 2250	M	11674	3212	465
3658 x 2000	I	1266	3239	431
3658 x 2125	I	1270	3367 <sup>3</sup>	459



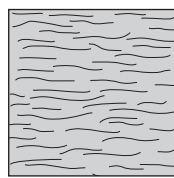
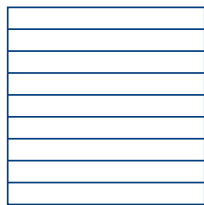

Timber Effect / Titan (CH 703)

Linear medium design



Premium

Surcharge for Standard Colours

Brickwork opening Width x Height (mm x mm)	Size Code			
3750 x 2000	<b>M</b>	12466	3109	442
3750 x 2125	<b>M</b>	12470	3209	469
3750 x 2250	<b>M</b>	12474	3307	498
3962 x 2000	<b>I</b>	1366	3341	467
3962 x 2125	<b>I</b>	1370	3467 <sup>3</sup>	497
4000 x 2000	<b>M</b>	13266	3274	471
4000 x 2125	<b>M</b>	13270	3356	501
4000 x 2250	<b>M</b>	13274	3464	531
4250 x 2000	<b>M</b>	131166	3415	501
4250 x 2125	<b>M</b>	131170	3522	533
4250 x 2250	<b>M</b>	131174	3624	563
4267 x 2000	<b>I</b>	1466	3440 <sup>1</sup>	503
4267 x 2125	<b>I</b>	1470	3582 <sup>1</sup>	535
4420 x 2000	<b>I</b>	14666	3531	522
4420 x 2125	<b>I</b>	14670	3676 <sup>1</sup>	554
4500 x 2000	<b>M</b>	14966	3594	531
4500 x 2125	<b>M</b>	14970	3705	563
4500 x 2250	<b>M</b>	14974	3787	597
4572 x 2000	<b>I</b>	1566	3556	538
4572 x 2125	<b>I</b>	1570	3710	572
4725 x 2000	<b>I</b>	15666	3630	557
4725 x 2125	<b>I</b>	15670	3770 <sup>3</sup>	592
4750 x 2000	<b>M</b>	15766	3669	560
4750 x 2125	<b>M</b>	15770	3790	595
4750 x 2250	<b>M</b>	15774	3894	630
4877 x 2000	<b>I</b>	1666	3694	574
4877 x 2125	<b>I</b>	1670	3842 <sup>1</sup>	611
5000 x 2000	<b>M</b>	16566	3815	590
5000 x 2125	<b>M</b>	16570	3916	627
5000 x 2250	<b>M</b>	16574	4017	663
5000 x 2375	<b>M</b>	16579	4119	700
5000 x 2500	<b>M</b>	16582	4219	736
5500 x 2000	<b>M</b>	18166	4123	648
5500 x 2125	<b>M</b>	18170	4234	689
5500 x 2250	<b>M</b>	18174	4342	729

<sup>1</sup> Available as stock door in Rosewood or Golden Oak timber effect.

<sup>2</sup> Available as stock door in Rosewood timber effect.

<sup>3</sup> Available as stock door in Golden Oak timber effect.

Prices in bold are generally a stock item. Non-bold prices require a longer lead-time.

- I** Imperial door sizes.
- M** Metric door sizes. Extended lead time of 4-6 weeks.



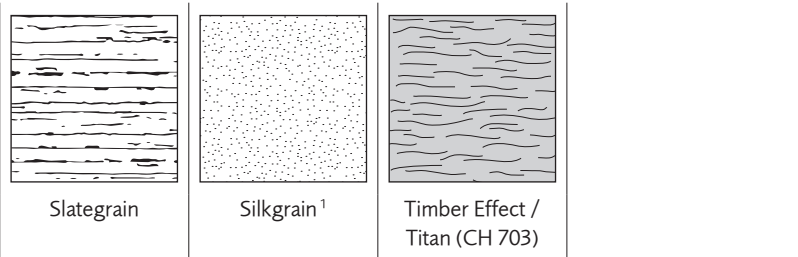
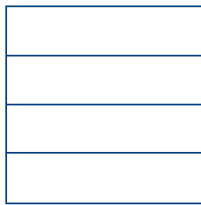

- Supplied as standard with tension spring gear. Torsion spring fitting available for Premium doors at £ 111 surcharge.
- Supplied as standard with torsion spring gear. Low headroom fitting available at £ 180 surcharge.

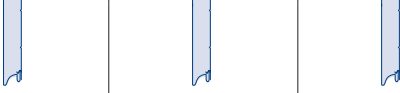
Purpose-made sizes available upon request. Non standard colours also available upon request. Doors supplied without locking as standard (see options on page 66 for handles). For window options please see page 49.

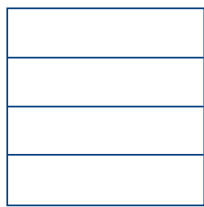
**Linear large design**

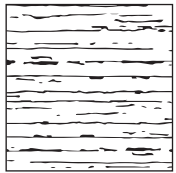
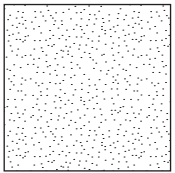
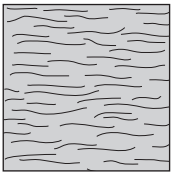
Brickwork opening Width x Height (mm x mm)	Size Code				Surcharge for Standard Colours	Surcharge for Non-Std. Colours	Surcharge for Special RAL
		Premium	Premium	Premium			
2080 x 2000	I 61066	1575	1977	2171	246	402	782
2080 x 2080	I 610610	1634	2002	2195	256	418	813
2134 x 2000	I 7066	1634	1977	2171	253	411	802
2134 x 2125	I 7070	1691	<b>2002</b>	2195	268	437	852
2250 x 1900	M 7462	1742	2096	2305	250	407	792
2250 x 2000	M 7466	1790	2133	2343	266	434	845
2250 x 2125	M 7470	1790	2137	2345	283	461	899
2286 x 2000	I 7666	1634	1977	2171	270	441	860
2286 x 2125	I 7670	1691	<b>2002</b>	-	288	468	912
2286 x 2250	I 7674	1710	<b>2090</b>	2294	303	496	967
2286 x 2375	I 7679	1848	2099	2302	320	523	1020
2286 x 2500	I 7682	1842	2151	2358	337	552	1074
2375 x 1900	M 7962	1742	2096	2305	263	430	837
2375 x 2000	M 7966	1738	2102	2309	281	459	894
2375 x 2125	M 7970	1741	2105	2310	297	486	949
2375 x 2250	M 7974	1769	2167	2380	316	514	1004
2438 x 2000	I 8066	1721	2088	2295	289	469	916
2438 x 2125	I 8070	1789	<b>2132</b>	2342 <sup>2</sup>	306	499	973
2438 x 2250	I 8074	1799	2235	2456	324	528	1030
2438 x 2375	I 8079	1940	2292	2519	342	558	1087
2438 x 2500	I 8082	1932	2355	2588	360	588	1145
2500 x 1900	M 8262	1742	2096	2305	278	451	880
2500 x 2000	M 8266	1738	2102	2309	295	482	939
2500 x 2125	M 8270	1741	2105	2310	314	512	998
2500 x 2250	M 8274	1769	2167	2380	332	541	1057
2500 x 2375	M 8279	1872	2273	2495	351	572	1116
2500 x 2500	M 8282	1871	2274	2494	369	601	1175
2500 x 2750	M 8290	2279	-	-	406	662	1291
2591 x 2000	I 8666	1721	2088	2295	306	499	973
2591 x 2125	I 8670	1789	<b>2132</b>	2342	325	531	1034
2625 x 2125	M 8770	1975	2429	2676	329	537	1048
2740 x 2000	I 9066	1869	<b>2298</b>	2532	324	528	1029
2740 x 2125	I 9070	1934	2331	2568	345	561	1094
2750 x 2000	M 9166	2004	2451	2701	325	531	1033
2750 x 2125	M 9170	2069	2502	2757	346	563	1098
2750 x 2250	M 9174	2076	2630	2899	365	596	1162
2750 x 2375	M 9179	2128	2691	2966	386	629	1227
2750 x 2500	M 9182	2230	2755	3036	406	662	1291
2896 x 2000	I 9666	1955	2427	2676	342	558	1087
2896 x 2125	I 9670	2037	2462	2714	363	593	1156
3000 x 2000	M 91066	2257	2562	2826	354	577	1126
3000 x 2125	M 91070	2252	2559	2822	376	614	1197
3000 x 2250	M 91074	2272	2661	2933	399	650	1268
3000 x 2375	M 91079	2329	2793	3081	421	686	1337
3000 x 2500	M 91082	2427	2832	3123	442	723	1409
3000 x 3000	M 910910	2957	3837	4246	531	866	1690
3048 x 2000	I 1066	1888	2427	2676	360	588	1145
3048 x 2125	I 1070	1956	2462	2714	383	625	1216
3250 x 2000	M 10866	2274	2939	3251	384	627	1221
3250 x 2125	M 10870	2336	2985	3302	407	665	1296
3250 x 2250	M 10874	2386	3042	3362	431	705	1373
3353 x 2000	I 1166	2238	2888	3193	395	646	1259
3353 x 2125	I 1170	2327	2931	3240	421	686	1337
3500 x 2000	M 11666	2428	3007	3327	412	674	1315
3500 x 2125	M 11670	2490	3066	3391	439	715	1397
3500 x 2250	M 11674	2540	3115	3444	465	758	1479
3658 x 2000	I 1266	2641	3265	3617	431	705	1373
3658 x 2125	I 1270	2745	3324	3683	459	748	1459
3750 x 2000	M 12466	2570	3061	3386	442	723	1409



								
		Slategrain	Silkgrain <sup>1</sup>	Timber Effect / Titan (CH 703)				
Linear large design								
Brickwork opening Width x Height (mm x mm)		Premium	Premium	Premium	Surcharge for Standard Colours	Surcharge for Non-Std. Colours	Surcharge for Special RAL	
3750 x 2125	<b>M</b>	12470	2640	3084	3411	469	767	1497
3750 x 2250	<b>M</b>	12474	2698	3157	3492	498	812	1586
3962 x 2000	<b>I</b>	1366	2741	3369	3735	467	764	1487
3962 x 2125	<b>I</b>	1370	2846	3417	3787	497	810	1581
4000 x 2000	<b>M</b>	13266	2708	3293	3649	471	770	1502
4000 x 2125	<b>M</b>	13270	2790	3381	3745	501	818	1596
4000 x 2250	<b>M</b>	13274	2846	3459	3832	531	866	1690
4250 x 2000	<b>M</b>	131166	2861	3490	3870	501	818	1596
4250 x 2125	<b>M</b>	131170	2946	3562	3948	533	870	1695
4250 x 2250	<b>M</b>	131174	3009	3628	4021	563	920	1795
4267 x 2000	<b>I</b>	1466	2847	3472	3851	503	820	1603
4267 x 2125	<b>I</b>	1470	2962	<b>3529</b>	3913 <sup>3</sup>	535	873	1702
4420 x 2000	<b>I</b>	14666	2943	<b>3568</b>	3959	522	850	1660
4420 x 2125	<b>I</b>	14670	3063	3623	4020	554	903	1763
4500 x 2000	<b>M</b>	14966	3012	3558	3946	531	866	1690
4500 x 2125	<b>M</b>	14970	3103	3673	4075	563	920	1795
4500 x 2250	<b>M</b>	14974	3163	3761	4171	597	974	1901
4572 x 2000	<b>I</b>	1566	2998	3607	4003	538	879	1718
4572 x 2125	<b>I</b>	1570	3118	3664	4066	572	935	1824
4725 x 2000	<b>I</b>	15666	3130	3672	4077	557	909	1775
4725 x 2125	<b>I</b>	15670	3253	3736	4148	592	966	1885
4750 x 2000	<b>M</b>	15766	3105	3714	4120	560	914	1783
4750 x 2125	<b>M</b>	15770	3201	3801	4218	595	971	1896
4750 x 2250	<b>M</b>	15774	3255	3891	4316	630	1027	2006
4877 x 2000	<b>I</b>	1666	2998	3738	4151	574	938	1832
4877 x 2125	<b>I</b>	1670	3118	3804	4225	611	997	1945
5000 x 2000	<b>M</b>	16566	3202	3860	4285	590	961	1877
5000 x 2125	<b>M</b>	16570	3268	3943	4377	627	1022	1995
5000 x 2250	<b>M</b>	16574	3330	4033	4475	663	1082	2113
5000 x 2375	<b>M</b>	16579	3394	4126	4578	700	1142	2229
5000 x 2500	<b>M</b>	16582	3457	4222	4685	736	1203	2346
5500 x 2000	<b>M</b>	18166	3430	4014	4459	648	1058	2065
5500 x 2125	<b>M</b>	18170	3521	4096	4549	689	1123	2193
5500 x 2250	<b>M</b>	18174	3609	4237	4706	729	1191	2323

<sup>1</sup> Silkgrain surface supplied with tension spring gear up to 3048 mm wide.

<sup>2</sup> Available as stock door in Golden Oak timber effect.

<sup>3</sup> Available as stock door in Rosewood or Golden Oak timber effect.

Prices in bold are generally a stock item. Non-bold prices require a longer lead-time.

- I** Imperial door sizes.
- M** Metric door sizes. Extended lead time of 4-6 weeks.

-  Supplied as standard with tension spring gear. Torsion spring fitting available for Premium doors at £ 111 surcharge.
-  Supplied as standard with torsion spring gear. Low headroom fitting available at £ 180 surcharge.

Purpose-made sizes available upon request. Non standard colours also available upon request. Doors supplied without locking as standard (see options on page 66 for handles). For window options please see page 49.

For Slategrain models, the door section has a Slategrain texture but the cover profiles and fascia are smooth.

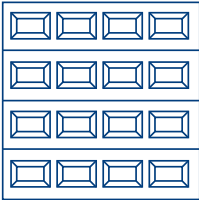

**Woodgrain Premium (42 mm insulated)**

**Georgian design**

Door width

Door Height	2000	2250	2375	2500	2750	3000	3250	3500	3750	4000	4250	4500	4750	5000	5250	5500
1900	2055	2064	2096	2284	2384	2683	2856	3121	3170	3233	3320	2329	2522	3552	3651	
2000	2076	2085	2114	2342	2519	2717	2920	3163	3231	3320	3409	3485	3555	3627	3727	
2080	2087	2099	2125	2374	2556	2733	2989	3199	3285	3409	3501	3575	3623	3700	3802	
2125	2087	2099	2125	2374	2556	2733	2989	3199	3285	3409	3501	3575	3623	3700	3802	
2205	2208	2230	2314	2420	2719	2763	3069	3274	3345	3495	3605	3657	3704	3782	3888	
2250	2119	2143	2221	2324	2608	2763	3069	3274	3345	3495	3605	3657	3704	3782	3888	
2375	2145	2182	2251	2371	2659	2835	3124	3342	3409	3552	3692	3754	3899	3980	4093	
2500	2187	2238	2288	2462	2756	2926	3180	3409	3476	3628	3741	3853	4091	4179	4298	
2600	2251	2297	2330	2558	2867	3023	3273	3479	3545	3718	3927	4044	4294	4388	4511	
2750	2422	2475	2485	2801	3050	3105	3326	3545	3698	3877	4097	4223	4486	4586	4715	
2850	2726	2786	2978	3233	3456	3499	3628	3695	3860	4047	4283	4408	4683	4789	-	
3000	3012	3060	3130	3320	3542	3583	3740	3848	4021	4218	4457	4587	4872	-	-	

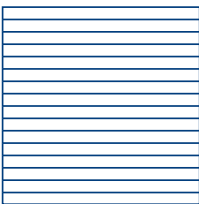

**Woodgrain Premium (42 mm insulated)**

**Linear small design**

Door width

Door Height	2000	2250	2375	2500	2750	3000	3250	3500	3750	4000	4250	4500	4750	5000	5250	5500
1900	1537	1586	1631	1826	2051	2181	2360	2367	2470	2577	2675	2768	2863	3018	3132	
2000	1594	1636	1681	1897	2114	2246	2433	2444	2542	2676	2774	2870	2944	3106	3224	
2080	1639	1679	1726	1947	2171	2309	2501	2523	2614	2755	2868	2967	3026	3191	3310	
2125	1639	1679	1726	1947	2171	2309	2501	2523	2614	2755	2868	2967	3026	3191	3310	
2205	1675	1718	1748	1969	2207	2369	2577	2595	2678	2839	2973	3044	3118	3291	3417	
2250	1675	1718	1748	1969	2207	2369	2577	2595	2678	2839	2973	3044	3118	3291	3417	
2375	1711	1757	1778	2014	2247	2427	2628	2667	2750	2918	3073	3162	3285	3463	3596	
2500	1742	1785	1819	2068	2290	2524	2712	2735	2820	3006	3135	3273	3445	3638	3772	
2600	1795	1841	1887	2172	2385	2620	2777	2820	2889	3092	3291	3432	3614	3816	3959	
2750	1969	2024	2082	2412	2654	2714	2854	2893	3011	3229	3435	3584	3773	3982	4132	
2850	2170	2221	2276	2512	2753	2805	2969	3019	3142	3366	3584	3742	3941	4157	-	
3000	2252	2321	2380	2609	2856	2897	3086	3139	3272	3502	3728	3895	4103	-	-	

■ Supplied with tensions spring as standard. Optional torsion spring available at additional cost, please see page 66.

□ These doors are only available with torsion spring.

For further options please see page 66.

Only fixed door heights are available on Georgian Premium sectional doors.

For intermediate heights, between designated heights in the table above please add £ 155 (for example, a required height of 2175 mm would be taken from the designated height 2205 mm).



**Woodgrain Premium (42 mm insulated)**

**Linear medium design**

Door width

Door Height	2000	2250	2375	2500	2750	3000	3250	3500	3750	4000	4250	4500	4750	5000	5250	5500
1900	1537	1586	1631	1827	2051	2181	2360	2367	2469	2577	2675	2768	2863	3018	3133	
2000	1593	1636	1679	1895	2112	2245	2431	2442	2540	2674	2773	2868	2943	3106	3223	
2080	1640	1678	1726	1947	2170	2309	2500	2524	2614	2754	2867	2966	3026	3191	3310	
2125	1640	1678	1726	1947	2170	2309	2500	2524	2614	2754	2867	2966	3026	3191	3310	
2205	1675	1716	1747	1968	2206	2369	2577	2595	2677	2838	2973	3043	3117	3291	3416	
2250	1675	1716	1747	1968	2206	2369	2577	2595	2677	2838	2973	3043	3117	3291	3416	
2375	1710	1756	1777	2013	2246	2426	2628	2667	2750	2917	3072	3162	3284	3463	3595	
2500	1740	1784	1819	2068	2288	2523	2710	2734	2819	3005	3134	3272	3444	3637	3771	
2600	1794	1841	1886	2170	2384	2619	2776	2819	2888	3090	3289	3431	3614	3814	3957	
2750	1968	2023	2081	2410	2653	2714	2853	2892	3012	3229	3433	3583	3773	3982	4132	
2850	2168	2220	2274	2510	2751	2804	2968	3016	3140	3364	3583	3741	3940	4156	-	
3000	2250	2319	2378	2607	2856	2896	3085	3137	3271	3502	3726	3893	4103	-	-	

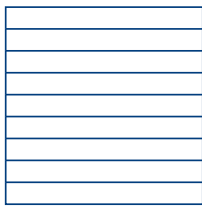



**Slategrain Premium (42 mm insulated)**

**Linear medium design**

Door width

Door Height	2000	2250	2375	2500	2750	3000	3250	3500	3750	4000	4250	4500	4750	5000	5250	5500
1900	1537	1586	1631	1827	2051	2181	2360	2367	2469	2577	2675	2768	2863	3018	3133	
2000	1593	1636	1679	1895	2112	2245	2431	2442	2540	2674	2773	2868	2943	3106	3223	
2080	1640	1678	1726	1947	2170	2309	2500	2524	2614	2754	2867	2966	3026	3191	3310	
2125	1640	1678	1726	1947	2170	2309	2500	2524	2614	2754	2867	2966	3026	3191	3310	
2205	1675	1716	1747	1968	2206	2369	2577	2595	2677	2838	2973	3043	3117	3291	3416	
2250	1675	1716	1747	1968	2206	2369	2577	2595	2677	2838	2973	3043	3117	3291	3416	
2375	1710	1756	1777	2013	2246	2426	2628	2667	2750	2917	3072	3162	3284	3463	3595	
2500	1740	1784	1819	2068	2288	2523	2710	2734	2819	3005	3134	3272	3444	3637	3771	
2600	1794	1841	1886	2170	2384	2619	2776	2819	2888	3090	3289	3431	3614	3814	3957	
2750	1968	2023	2081	2410	2653	2714	2853	2892	3012	3229	3433	3583	3773	3982	4132	
2850	2168	2220	2274	2510	2751	2804	2968	3016	3140	3364	3583	3741	3940	4156	-	
3000	2250	2319	2378	2607	2856	2896	3085	3137	3271	3502	3726	3893	4103	-	-	

 Supplied with tensions spring as standard. Optional torsion spring available at additional cost, please see page 66.

 These doors are only available with torsion spring.

For further options please see page 66.

For intermediate heights, between designated heights in the table above please add £ 155 (for example, a required height of 2175 mm would be taken from the designated height 2205 mm).



**Silkgrain Premium (42 mm insulated)**

**Linear medium design**

Door Height	Door width															
	2000	2250	2375	2500	2750	3000	3250	3500	3750	4000	4250	4500	4750	5000	5250	5500
1900	1788	1853	1908	2152	2431	2608	2826	2832	2962	3085	3208	3322	3438	3567	3705	
2000	1860	1918	1968	2236	2510	2687	2915	2926	3046	3208	3330	3441	3538	3670	3813	
2080	1925	1969	2024	2296	2577	2760	2996	3018	3127	3304	3438	3555	3631	3769	3916	
2125	1925	1969	2024	2296	2577	2760	2996	3018	3127	3304	3438	3555	3631	3769	3916	
2205	1993	2041	2075	2363	2653	2843	3082	3104	3212	3399	3567	3657	3749	3891	4041	
2250	1993	2041	2075	2363	2653	2843	3082	3104	3212	3399	3567	3657	3749	3891	4041	
2375	2057	2114	2154	2442	2725	2901	3149	3195	3291	3501	3689	3794	3943	4096	4252	
2500	2124	2179	2230	2551	2841	3017	3243	3277	3376	3600	3759	3926	4136	4303	-	
2600	-	-	-	-	-	-	-	-	-	-	-	-	-	-	-	
2750	2477	2551	2622	2877	3153	3196	3403	3464	3951	4181	4322	4524	-	-	-	
2850	-	-	-	-	-	-	-	-	-	-	-	-	-	-	-	
3000	2686	2766	2843	3121	3419	3469	3694	3764	4110	4412	-	-	-	-	-	

Supplied with tensions spring as standard. Optional torsion spring available at additional cost, please see page 66.

These doors are only available with torsion spring.

For further options please see page 66.

For intermediate heights, between designated heights in the table above please add £ 155 (for example, a required height of 2175 mm would be taken from the designated height 2205 mm). Sandgrain doors are only available in the following colours: Anthracite Grey (RAL 7016) and Traffic White (RAL 9016). Other colours and RAL to choose are not possible.

For Linear Medium (Silkgrain) models, price available on request for door sizes 4750 mm to 5000 mm width and 2600 mm to 2850 mm height.

For Linear Medium (Silkgrain) models, price available on request for door sizes 5000 mm to 5500 mm width and 2600 mm to 2750 mm height.

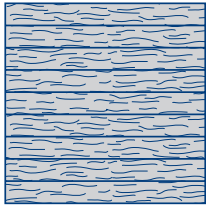

**Timber Effect / Titan (CH 703) Premium (42 mm insulated)**

**Linear medium design**

Door width

Door Height	2000	2250	2375	2500	2750	3000	3250	3500	3750	4000	4250	4500	4750	5000	5250	5500
1900	1967	2041	2102	2378	2693	2893	3139	3145	3291	3431	3569	3698	3829	3975	4132	
2000	2042	2110	2165	2467	2776	2976	3235	3246	3384	3566	3703	3830	3938	4088	4248	
2080	2114	2165	2227	2535	2853	3059	3325	3350	3474	3672	3825	3958	4043	4199	4365	
2125	2114	2165	2227	2535	2853	3059	3325	3350	3474	3672	3825	3958	4043	4199	4365	
2205	2190	2245	2281	2607	2934	3150	3419	3445	3566	3779	3968	4068	4173	4334	4504	
2250	2190	2245	2281	2607	2934	3150	3419	3445	3566	3779	3968	4068	4173	4334	4504	
2375	2260	2324	2371	2694	3014	3213	3493	3546	3654	3892	4104	4222	4391	4563	4740	
2500	2336	2397	2454	2817	3144	3343	3598	3636	3749	4001	4181	4370	4608	4794	4983	
2600	2717	2801	2880	3170	3482	3530	3762	3833	4382	4643	4802	5029	5148	5349	5564	
2750	2728	2812	2892	3181	3493	3542	3773	3844	4393	4654	4814	5040	5160	5361	5575	
2850	2946	3037	3124	3439	3774	3830	4085	4166	4555	4895	4966	5196	5480	-	-	
3000	2960	3050	3138	3452	3788	3843	4099	4179	4569	4908	4980	5209	5493	-	-	

Supplied with tension spring as standard. Optional torsion spring available at additional cost, please see page 66.

These doors are only available with torsion spring.

For further options please see page 66.

For intermediate heights, between designated heights in the table above please add £ 155 (for example, a required height of 2175 mm would be taken from the designated height 2205 mm).

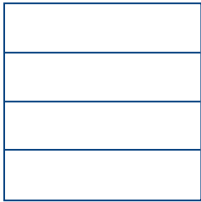

**Woodgrain Premium (42 mm insulated)**

**Linear large design**

Door Height	Door width															
	2000	2250	2375	2500	2750	3000	3250	3500	3750	4000	4250	4500	4750	5000	5250	5500
1900	1866	1931	1988	2243	2531	2698	2933	2941	3074	3209	3336	3459	3582	3786	3930	
2000	1934	1989	2042	2322	2606	2777	3018	3034	3161	3335	3459	3583	3679	3887	4039	
2080	1991	2042	2098	2387	2681	2854	3105	3130	3247	3433	3575	3704	3786	3995	4151	
2125	1991	2042	2098	2387	2681	2854	3105	3130	3247	3433	3575	3704	3786	3995	4151	
2205	2032	2084	2125	2412	2708	2932	3193	3223	3329	3534	3708	3803	3896	4120	4287	
2250	2032	2084	2125	2412	2708	2932	3193	3223	3329	3534	3708	3803	3896	4120	4287	
2375	2077	2127	2157	2462	2762	2999	3258	3310	3417	3632	3832	3950	4110	4338	4510	
2500	2107	2167	2213	2531	2815	3119	3364	3396	3500	3740	3911	4089	4315	4558	4735	
2600	2168	2234	2292	2655	2935	3239	3437	3498	3584	3851	4105	4287	4524	4785	4968	
2750	2389	2463	2536	2965	3278	3356	3534	3588	3742	4021	4286	4483	4730	4998	5192	
2850	2647	2715	2784	3086	3403	3464	3678	3742	3903	4191	4476	4681	4939	5221	-	
3000	2748	2836	2915	3212	3530	3584	3826	3895	4065	4369	4657	4871	5144	-	-	

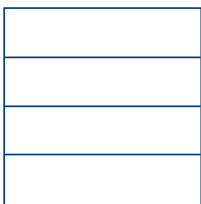

**Slategrain Premium (42 mm insulated)**

**Linear large design**

Door Height	Door width															
	2000	2250	2375	2500	2750	3000	3250	3500	3750	4000	4250	4500	4750	5000	5250	5500
1900	1866	1931	1988	2243	2531	2698	2933	2941	3074	3209	3336	3459	3582	3786	3930	
2000	1934	1989	2042	2322	2606	2777	3018	3034	3161	3335	3459	3583	3679	3887	4039	
2080	1991	2042	2098	2387	2681	2854	3105	3130	3247	3433	3575	3704	3786	3995	4151	
2125	1991	2042	2098	2387	2681	2854	3105	3130	3247	3433	3575	3704	3786	3995	4151	
2205	2032	2084	2125	2412	2708	2932	3193	3223	3329	3534	3708	3803	3896	4120	4287	
2250	2032	2084	2125	2412	2708	2932	3193	3223	3329	3534	3708	3803	3896	4120	4287	
2375	2077	2127	2157	2462	2762	2999	3258	3310	3417	3632	3832	3950	4110	4338	4510	
2500	2107	2167	2213	2531	2815	3119	3364	3396	3500	3740	3911	4089	4315	4558	4735	
2600	2168	2234	2292	2655	2935	3239	3437	3498	3584	3851	4105	4287	4524	4785	4968	
2750	2389	2463	2536	2965	3278	3356	3534	3588	3742	4021	4286	4483	4730	4998	5192	
2850	2647	2715	2784	3086	3403	3464	3678	3742	3903	4191	4476	4681	4939	5221	-	
3000	2748	2836	2915	3212	3530	3584	3826	3895	4065	4369	4657	4871	5144	-	-	

Supplied with tension spring as standard. Optional torsion spring available at additional cost, please see page 66.

These doors are only available with torsion spring.

For further options please see page 66.

For intermediate heights, between designated heights in the table above please add £ 155 (for example, a required height of 2175 mm would be taken from the designated height 2205 mm).



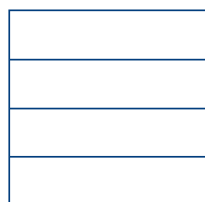

### Silkgrain Premium (42 mm insulated)

#### Linear large design

Door width

Door Height	2000	2250	2375	2500	2750	3000	3250	3500	3750	4000	4250	4500	4750	5000	5250	5500
1900	2199	2212	2223	2456	2695	2924	3006	3048	3069	3264	3364	3447	3478	3541	3608	
2000	2231	2236	2251	2519	2790	3021	3094	3150	3303	3387	3474	3662	3694	3762	3833	
2080	2256	2261	2268	2573	2836	3070	3153	3173	3366	3481	3591	3717	3782	3854	3931	
2125	2256	2261	2268	2573	2836	3070	3153	3173	3366	3481	3591	3717	3782	3854	3931	
2205	2300	2321	2353	2704	2982	3130	3201	3250	3466	3560	3690	3807	3870	3943	4019	
2250	2300	2321	2353	2704	2982	3130	3201	3250	3466	3560	3690	3807	3870	3943	4019	
2375	2317	2341	2401	2765	3007	3186	3269	3360	3559	3655	3795	3951	4077	4150	4233	
2500	2331	2380	2461	2829	3052	3234	3317	3418	3627	3739	3903	4051	4276	4352	-	
2600	2499	2557	2650	3112	3295	3398	3466	3596	3853	3999	4265	4426	-	-	-	
2750	2511	2568	2661	3123	3307	3410	3478	3608	3864	4010	4276	4438	-	-	-	
2850	3018	3082	3123	3439	3623	3719	3790	3907	4185	4346	4630	-	-	-	-	
3000	3032	3096	3137	3452	3636	3732	3803	3921	4199	4359	4644	-	-	-	-	

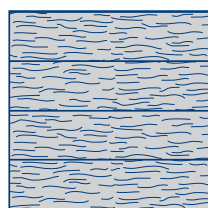

### Timber Effect / Titan (CH 703) Premium (42 mm insulated)

#### Linear large design

Door width

Door Height	2000	2250	2375	2500	2750	3000	3250	3500	3750	4000	4250	4500	4750	5000	5250	5500
1900	2393	2408	2421	2678	2943	3197	3288	3336	3358	3574	3686	3778	3811	3882	3955	
2000	2427	2432	2450	2746	3046	3304	3384	3447	3615	3710	3804	4014	4048	4125	4204	
2080	2453	2459	2466	2804	3097	3356	3448	3470	3683	3811	3933	4073	4144	4225	4310	
2125	2453	2459	2466	2804	3097	3356	3448	3470	3683	3811	3933	4073	4144	4225	4310	
2205	2500	2524	2558	2948	3256	3420	3498	3554	3794	3897	4041	4172	4241	4321	4406	
2250	2500	2524	2558	2948	3256	3420	3498	3554	3794	3897	4041	4172	4241	4321	4406	
2375	2517	2544	2612	3013	3282	3481	3574	3675	3894	4001	4156	4330	4469	4550	4643	
2500	2531	2586	2675	3083	3332	3532	3625	3737	3968	4094	4275	4440	4688	4774	4873	
2600	2716	2780	2882	3395	3599	3713	3789	3932	4216	4378	4674	4853	5132	5227	5336	
2750	2727	2792	2894	3407	3611	3724	3800	3943	4228	4389	4685	4864	5143	5238	5347	
2850	3288	3359	3405	3755	3959	4065	4144	4274	4583	4761	5076	5278	5581	-	-	
3000	3302	3373	3418	3768	3972	4078	4158	4287	4596	4775	5090	5292	5594	-	-	

 Supplied with tension spring as standard. Optional torsion spring available at additional cost, please see page 66.

 These doors are only available with torsion spring.

For further options please see page 66.

For intermediate heights, between designated heights in the table above please add £ 155 (for example, a required height of 2175 mm would be taken from the designated height 2205 mm). Please note, heights between 2505 mm - 2570 mm and 2755 mm - 2870 mm are not available in Silkgrain, Timber Effect and Titan (CH 703) doors.

For Linear Medium (Silkgrain) models, price available on request for door sizes 4750 mm to 5000 mm width and 2600 mm to 2850 mm height.

For Linear Medium (Silkgrain) models, price available on request for door sizes 5000 mm to 5500 mm width and 2600 mm to 2750 mm height.

## Options for sectional doors

add

Special anchor set (required if you fix the door between brickwork and fasten the frame on the side).  
If using special anchor set 90 mm cover profiles will be required to cover fixing holes. Two anchor sets are required for doors over 2250 mm high.

80

Please note: Frame legs for brown and any coloured doors come in white as standard, matching cover profiles are available. Silkgrain, Foil Coated Timber Effect and Titan Metallic (CH 703) are available ex-stock. Please however note Colours and RAL to choose must be ordered with the door and cannot be ordered as a spare part at a later time.

## Cover Profiles

Door height	White				Standard Colour				RAL to choose				Special RAL				Foil Coated Timber Effect / Titan (CH 703)	
	Woodgrain		Silkgrain		Woodgrain		Silkgrain (Smooth)		Woodgrain		Silkgrain (Smooth)		Woodgrain		Silkgrain		55	90
	55	90	55	90	55	90	55	90	55	90	55	90	55	90	55	90		
1875	86	120	90	131	100	150	122	157	144	212	150	229	159	250	166	266	134	167
2000	91	126	97	140	106	157	130	166	154	225	160	243	168	266	178	284	142	178
2125	97	134	103	148	113	167	140	178	163	239	169	259	179	282	188	300	150	189
2250	102	143	109	158	119	177	147	188	173	254	180	273	191	298	199	319	160	200
2375	109	151	114	165	126	191	156	198	182	268	191	290	199	315	211	335	168	212
2500	114	158	120	175	132	196	163	208	192	282	199	304	211	331	222	354	177	222
For door heights not specified above, use formula: door height x price below (i.e. door height 2600 for "White Woodgrain 55": 2.6 x 46 = £ 119,6)																		
	46	63	49	68	53	79	64	82	76	112	79	121	85	132	89	143	71	89

Purpose-made width cut-down service (check for size limitations).

88

Purpose-made height cut-down service (check for size limitations).

129

Classic black handle set and lock for on-site installation

89

White finish cast aluminium handle set and lock for on-site installation

196

Brushed stainless steel finish cast aluminium handle set and lock for on-site installation

213

Factory cut hole for handle and lock available with a 2 week increase in lead-time (complete with classic black handle as standard) <sup>1</sup>

139

Standard headroom torsion spring for sectional door less than 4000 mm wide <sup>2</sup>

116

Low headroom tracks arrangement for torsion spring door over 4000 mm wide (when purchased with door) <sup>2</sup>

180

<sup>1</sup> Please note: Only available for stock doors (highlighted in bold) on pages 50 - 59.

<sup>2</sup> Excluding Silkgrain. For Silkgrain surface finish, torsion spring gear can be only be supplied on doors over 3050 mm wide.

## ThermoFrame set

### ThermoFrame set 4

RM height	up to 3000 mm	3x plastic angle profiles	Length 3210 mm	per set	448
LZ width	up to 3210 mm				

### ThermoFrame set 5

RM height	up to 3000 mm	2x plastic angle profiles	Length 3210 mm	per set	448
LZ width	from 3210 mm up to 6000 mm	1x plastic angle profile	Length 6000 mm		

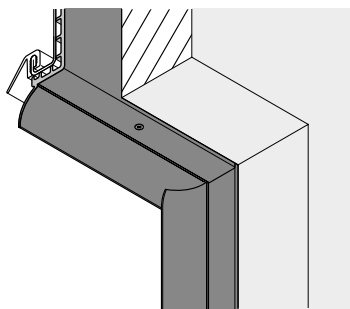

Set consists of

- 3x Plastic angle profiles black 84 x 22.5 mm with lip seal

**Note on set 4 and 5 (frame covering not possible):**

- A single-skinned fascia panel is fitted. Required headroom corresponds with track application Z, N and L.
- Please also note the supplements and limitations in the technical manual!

## Options for purpose-made sectional doors

Standard colour finish for purpose made sectional doors (i.e. 2000 mm x 2125 mm is an area of 4.25 m <sup>2</sup> )	per m <sup>2</sup>	60
RAL to choose or CH 703 colour finish for purpose made sectional doors	per m <sup>2</sup>	96
Special colour finish for purpose made sectional doors	per m <sup>2</sup>	189
Top fascia for sectional doors (95 mm). Woodgrain surface texture (Traffic White RAL 9016)	per m	46
Top fascia for sectional doors (95 mm). Sandgrain surface texture (Traffic White RAL 9016)	per m	51
Top fascia for sectional doors (95 mm). Silkgrain surface texture (Traffic White RAL 9016)	per m	51
Top fascia for sectional doors (95 mm). Timber Effect surface texture (Timber Effect and CH 703)	per m	73
Top fascia for sectional doors (95 mm). Standard colour finish	per m <sup>2</sup>	60
Top fascia for sectional doors (95 mm). RAL to choose or CH 703	per m <sup>2</sup>	98
Top fascia for sectional doors (95 mm). Special RAL colours	per m <sup>2</sup>	189

Sectional doors up to 4000 mm wide and/ or 2500 mm high (excluding Silkgrain surface finish) and  
 Sectional doors up to 3048 mm wide and/ or 2500 mm high (with Silkgrain surface finish):

These doors come with tension spring fitting. With doors from the Premium range the tension springs can be replaced by torsion springs as an option. Tension springs are suitable for low headroom installations. For a low headroom installation with torsion springs please order low headroom track set separately (changing to a low headroom option is not available as a retrofit).



**Sectional garage door  
 with tension spring fitting**

Minimum garage dimensions for manually operated doors

Headroom:	100 mm
Sideroom:	90 mm (each side)
Depth into garage:	garage door height + 510 mm
Clear passage height for manually operated doors:	garage door height – 80 mm

Minimum garage dimensions for doors with GaraMatic operator

Headroom	115 mm
Sideroom:	90 mm (each side)
Depth into garage:	for doors up to 2125 mm high: 3200 mm for doors up to 2500 mm high: 3450 mm for doors up to 3000 mm high: 4125 mm

Clear passage height  
for doors with  
GaraMatic operator:  
garage door height – 30 mm

Minimum ceiling height: 115 mm  
 Minimum ceiling height  
(with ThermoFrame): 145 mm

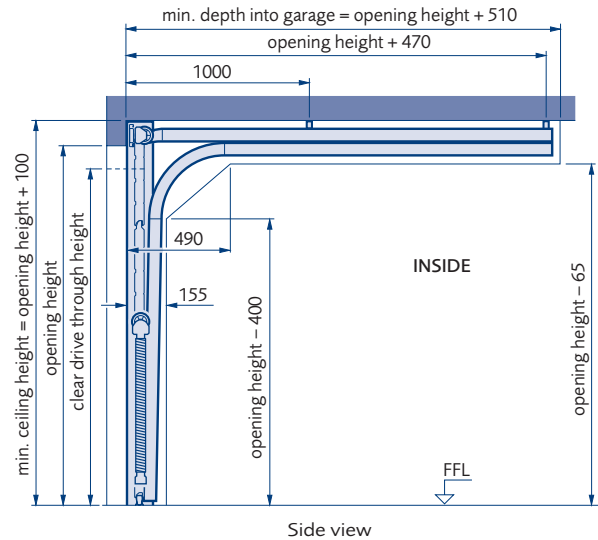

Side view

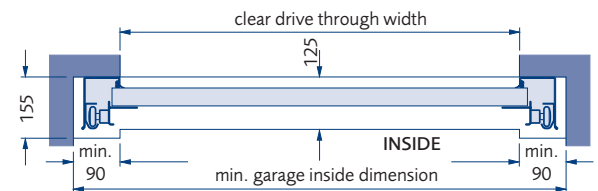

Plan view

**Sectional doors with torsion spring fitting wider than 4000 mm wide (excluding Silkgrain surface finish) and Sectional doors wider than 3048 mm wide (with Silkgrain surface finish):**

These doors come with torsion springs as standard. For a low headroom installation with torsion springs please order low headroom track pack (changing to a low headroom option is not available as a retrofit).



**Sectional garage door with torsion spring fitting**

Minimum garage dimensions for manually operated doors

Headroom:	210 mm
Sideroom:	90 mm (each side)
Depth into garage:	garage door height + 510 mm
Clear passage height for manually operated doors:	garage door height – 50 mm

Minimum garage dimensions for doors with GaraMatic operator

Headroom:	210 mm
Sideroom:	90 mm (each side)
Depth into garage:	for doors up to 2125 mm high: 3200 mm for doors up to 2500 mm high: 3450 mm for doors up to 3000 mm high: 4125 mm

Clear passage height for doors with

GaraMatic operator: full garage door height

Minimum ceiling height: 210 mm

Minimum ceiling height (with ThermoFrame): 255 mm

Excludes Silkgrain surface finish.

Torsion spring available for doors over 3000 mm x 2250 mm

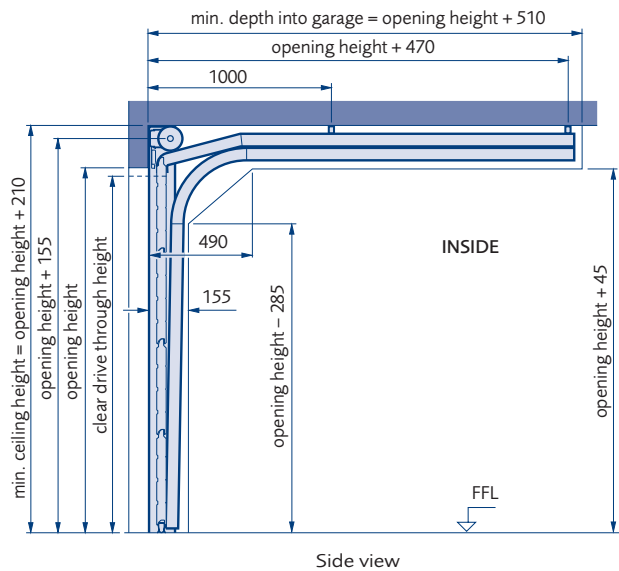

Side view

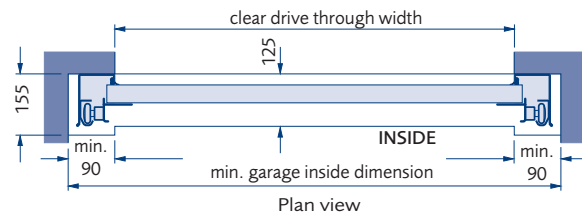

Plan view

Sectional doors with low-headroom torsion spring fitting wider than 4000 mm wide (excluding Silkgrain surface finish) and Sectional doors wider than 3048 mm wide (with Silkgrain surface finish):

These doors come with torsion springs as standard. For a low headroom installation with torsion springs please order low headroom track pack (changing to a low headroom option is not available as a retrofit).

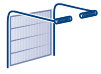

**Sectional garage door  
with low headroom torsion spring fitting**

Minimum garage dimensions for manually operated doors

Headroom:	100 mm
Sideroom:	90 mm (each side)
Depth into garage:	garage door height + 510 mm
Clear passage height for manually operated doors:	garage door height – 100 mm

Minimum garage dimensions for doors with GaraMatic operator

Headroom:	115 mm
Sideroom:	90 mm (each side)
Depth into garage:	for doors up to 2125 mm high: 3200 mm for doors up to 3000 mm high: 4125 mm
Clear passage height for doors with GaraMatic operator:	for doors up to 3000 mm wide: garage door height – 30 mm for doors wider than 3000 mm: garage door height – 80 mm

Minimum ceiling height: 115 mm

Minimum ceiling height (with ThermoFrame): 145 mm

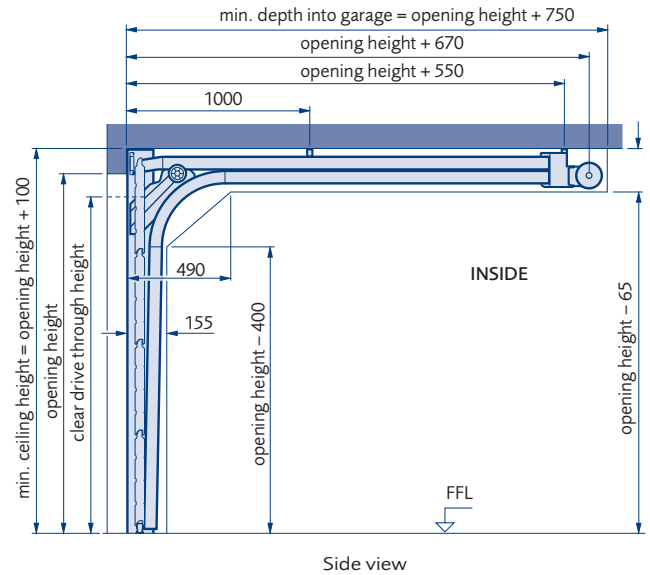

Side view

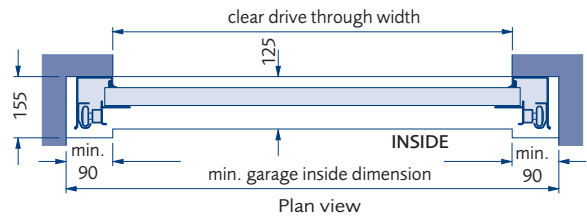

Plan view



# Automation and Accessories

## Operators

GaraMatic operators are an ideal match for all current Garador up & over and sectional garage doors. They are a tried and tested hardware combination, designed for use with Garador up & over or sectional garage doors, and prepared for easy installation. They feature energy efficient LED light, a power saving mode and a mechanical lock, built into the operator boom, to prevent forced lifting of the door.

## What's Included

All GaraMatic operators come as a complete set, including operator head, boom and two 4-button hand transmitters.



### BlueSecur App

The Garador BlueSecur app allows you to control your Series 4 GaraMatic operator from your android or ios smartphone. It allows you to operate the open/close, partial opening and integral light functions.



Both the GaraMatic 10 and GaraMatic 20 are supplied complete with an integrated bluetooth receiver, for control via Garador's BlueSecur smartphone app for android and ios devices. One free user key is included. Others available via in-app purchase. Please refer to Garador BlueSecur for pricing. The bluetooth receiver can be switched on and off. An optional bluetooth receiver is available as an add-on for the GaraMatic 9.



### BS EN 13241 Compliant

The combination of Garador garage doors with GaraMatic operators complies with the latest European safety standards.





## Operators



	GaraMatic 9	GaraMatic 10	GaraMatic 20
			
	<p><b>Peak forces</b> 750 N</p> <ul style="list-style-type: none"> <li>• Simple to operate</li> <li>• Soft start and stop</li> <li>• Max. opening speed 20 cm/s</li> <li>• Automatic safety reversal</li> <li>• Integral LED light with 10 LEDs</li> <li>• Low power consumption (less than 1 w in stand by mode)</li> <li>• Supplied with two 4-button hand transmitters (black end caps)</li> </ul>	<p><b>Peak forces</b> 800 N</p> <ul style="list-style-type: none"> <li>• Control element with 2x 7-segment display</li> <li>• Soft start and stop</li> <li>• Max. opening speed 25 cm/s</li> <li>• Automatic safety reversal</li> <li>• Adjustable integral LED light with 20 LEDs</li> <li>• Partial opening function</li> <li>• Self-closing timer option</li> <li>• Integrated bluetooth receiver</li> <li>• HCP interface to connect smarhome systems</li> <li>• Low power consumption (less than 1 w in stand by mode)</li> <li>• Supplied with two 4-button hand transmitters (chrome end caps)</li> <li>• BlueSecur App: One free user key included. Others available via in-app purchase</li> </ul>	<p><b>Peak forces</b> 1000 N</p> <ul style="list-style-type: none"> <li>• Control element with 2x 7-segment display</li> <li>• Soft start and stop</li> <li>• Max. opening speed 25 cm/s</li> <li>• Automatic safety reversal</li> <li>• Adjustable integral LED light with 30 LEDs</li> <li>• Partial opening function</li> <li>• Self-closing timer option</li> <li>• Integrated bluetooth receiver</li> <li>• HCP interface to connect smarhome systems</li> <li>• Low power consumption (less than 1 w in stand by mode)</li> <li>• Supplied with two 4-button hand transmitters (chrome end caps)</li> <li>• BlueSecur App: One free user key included. Others available via in-app purchase</li> </ul>
Canopy Doors <sup>1</sup>	660	830	885
Standard short boom <sup>2</sup> Retractable and Sectional Doors up to 2125 mm high	540	667	741
Medium boom <sup>2</sup>	576	703	777
Long boom <sup>2</sup>	692	818	892





<sup>1</sup> Canopy door price includes bow arm system. GaraMatic 9 supplied with two 2-channel hand transmitters.



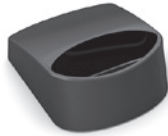

<sup>2</sup> For exact boom requirements see grid on page 77.









Accessories				
Article	Hand transmitter 5-channel (Bi-directional) in matt black	Hand transmitter 4-channel (Bi-directional) in matt black	Hand transmitter 4-channel (Bi-directional) in matt black (chrome caps)	Hand transmitter 5-channel (Bi-directional) in white
Reference No.	7471	7470	6809	6713
Price £	93	73	80	94

Accessories				
Article	Hand transmitter 5-channel (Bi- directional) in black	Hand transmitter 1-channel (Bi- directional) in black	Hand transmitter 4-channel (Bi- directional) in black	Hand transmitter station in black
Reference No.	6714	6710	6779	6719
Price £	94	80	76	15

Accessories				
Article	Hand transmitter station in white	Hand transmitter sun visor/ wall holder	1-channel (Bi-directional) transmitter for car cigarette lighter	2-channel (Bi-directional) transmitter for car cigarette lighter
Reference No.	6720	6784	6782	6783
Price £	15	14	73	73

Accessories				
Article	Hand transmitter 2-channel (Bi-directional) Green	Robust 3-channel (Bi-directional) hand transmitter	IT3 B Wired Wall Console	FIT 2 Bi-directional wireless wall console
Reference No.	6965	8880	8733	6718
Price £	105	108	52	109

Accessories				
Article	IT1 B Wired illuminated push button	Series 4 External Bluetooth Antenna to increase signal range	IT1-1 Internal Push Button	FCT 3 BS Radio code switch
Reference No.	2875	8128	695	6717
Price £	49	107	34	141

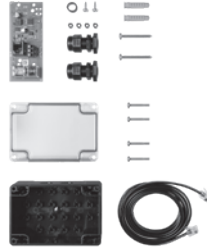
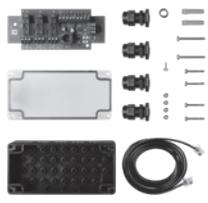
Accessories				
Article	FCT 10 Wireless Code Switch (flip lid) 868 mHz bi-directional	Series 4 External Bluetooth receiver (GaraMatic 9 add-on)	Options relay for control of garage light, warning light or limit switch report HOR-HCP	Series 4 Universal Adapter Print for control of operator light, partial open and venti- lation position UAP-1-HCP
Reference No.	6716	8129	8125	8421
Price £	212	171	71	130

Accessories

			
Article	EL301N External light beam device	Emergency Battery Backup HNA 18-4 (for Series 4 operators)	EL101 Internal light beam device
Reference No.	2884	8126	6786
Price £	170	279	103

## Additional options

De-latching kit Reference No. 705 for up & over doors, Garador single door range (437.195) (required to maintain mechanical locking system retractable doors only)	71
De-latching kit Reference No. 2643 for up & over doors, Garador double door range (437.197) (required to maintain mechanical locking system retractable doors only)	116
Emergency release Reference No. 704 for retractable up & over doors only (required if door is electrically operated and has no other personal access)	47
Emergency release Reference No. 703 for sectional door without handle and lock, or canopy up & over doors (required if door is electrically operated and has no other personal access)	65
Emergency release Reference No. 702 for sectional door with handle and lock (required if door is electrically operated and has no other personal access)	66
Lintel extension bracket Reference No. 709 for canopy doors (required if door is fitted between brickwork under the lintel)	65

## Operator Specifications

### Boom for canopy door including canopy bow arm

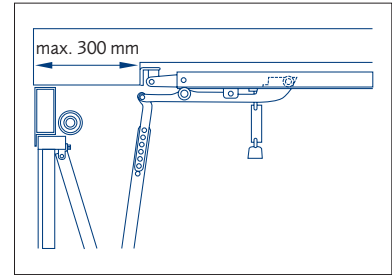
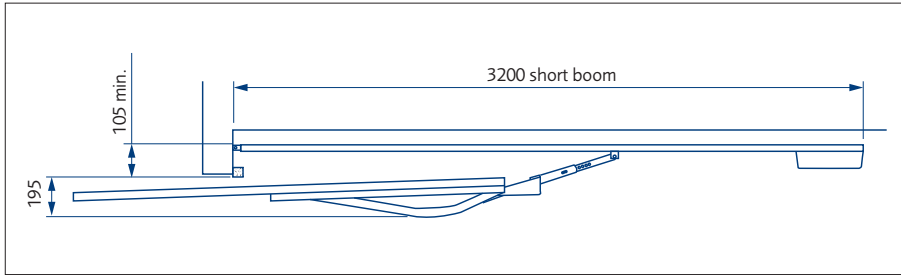

On horizontal doors the bow arm is to be fitted off centre.

Lintel extension bracket required for canopy doors fitted between the brickwork and under the lintel head.

### Boom for retractable door

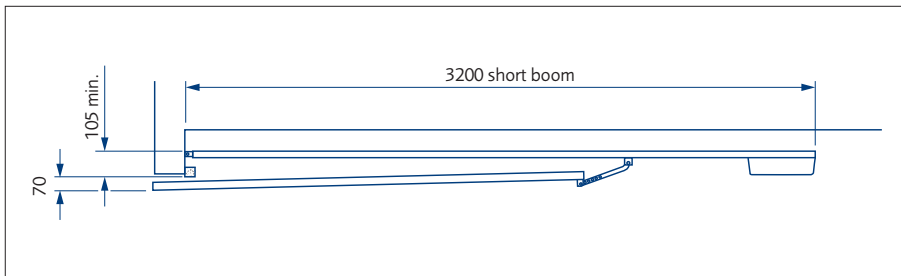

### Boom for sectional door

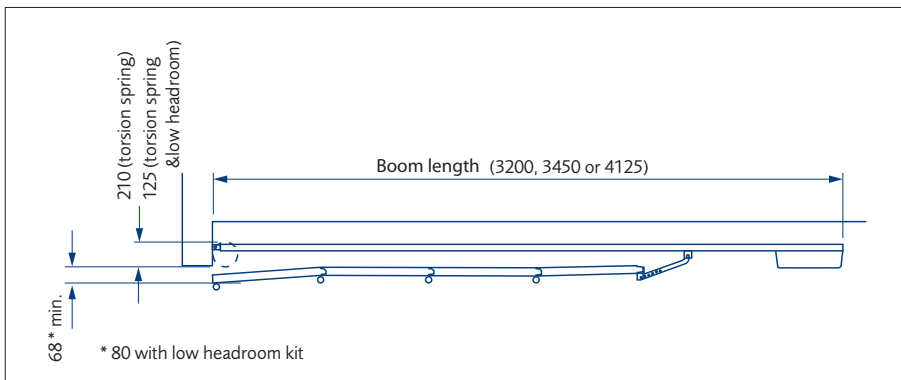

### Maximum Door Height to suit Operator Booms

	Torsion Spring	Tension and Low Headroom Spring	Travel distance
Short Boom	2250 mm	2125 mm	2475 mm
Medium Boom	2500 mm	2375 mm	2725 mm
Long Boom	3000 mm	3000 mm	3400 mm

# GaraRoll Roller Doors

## GaraRoll Insulated Roller Doors

Spring-compensated, automated roller garage door for domestic applications only. All doors are made to suit the opening with the actual door size relating to the structural opening width x height and the guides fitting on the reveals to maintain a full opening size. The GaraRoll is the only roller garage door to include the cover hood, which the curtain rolls into at the head of the garage door opening, as standard. The door is also supplied complete with a DuraBelt anti-scratch system, designed to provide a protective layer between each lath as they roll up when the door is open.

### Door curtain

77 mm rolled aluminium profile filled with 100 % CFC-free polyurethane rigid foam. Each lath is 15mm thick. Integrated windlocks fitted as standard.

### Surface

Colour finish with double layer coil coating quality paint system or foil-coated timber effect finish.

### Frame

Aluminium extrusion profile side guides with integrated plastic runners. Lintel and cover box made of steel. Colour of side guides and lintels supplied to match the door as standard. Except on foil-coated and deco paint timber effect doors where they are supplied in a solid brown paint finish. Cover box coated Grey White (RAL 9002).

### Counterbalance

Tension spring technology with lateral integral double tension springs and double cables encased within a transparent cover.

### Colours

Same colour inside and outside

- |                          |                              |                          |                              |
|--------------------------|------------------------------|--------------------------|------------------------------|
| - Light Ivory (RAL 1015) | - Moss Green (RAL 6005)      | - Agate Grey (RAL 7038)  | - White Aluminium (RAL 9006) |
| - Ruby Red (RAL 3003)    | - Slate Grey (RAL 7015)      | - Terra Brown (RAL 8028) | - Grey Aluminium (RAL 9007)  |
| - Purple Red (RAL 3004)  | - Anthracite Grey (RAL 7016) | - Cream (RAL 9001)       | - Traffic White (RAL 9016)   |
| - Steel Blue (RAL 5011)  | - Light Grey (RAL 7035)      | - Jet Black (RAL 9005)   | - Chartwell Green            |

Deco paint doors available in Anthracite Metallic (Noir 2100 Sable), Golden Oak and Rosewood, with the same finish inside and out.

Foil-coated doors available in Golden Oak and Rosewood, with the inside of the lath in dark brown (foil coat not available on GaraRoll external roller garage door).

### Operator and Control

Garador operator and control included. 24 V DC gear drive, mains voltage 230-240 V AC, 0.5 kW, opening speed approx. 11 cm/s, integrated door security kit, operator always located on left (viewed from inside), plastic housing. Micro-processor control in separate plastic housing, automatic teaching of auto safety cut-out and travel limits, soft start and soft stop, light, impulse control, adjustable automatic timer (hold-open time 30 sec. after activation, additional photocell required). Included: 2 hand transmitters and integral receiver, connecting lead with CEE plug, control buttons in cover of the control unit, integrated 2-minute garage light in control housing, quick release (operated from inside). Please note, a wired optical sensor is included as a mandatory safety feature for all GaraRoll doors over 5000 mm wide.

### Windows

Window size approx. 120 x 40 mm, number of windows per door section depends on door width. Windows made of clear synthetic pane with black window frame on exterior, transparent frame on interior. Maximum of 10 window sections per door.

Window arrangement:

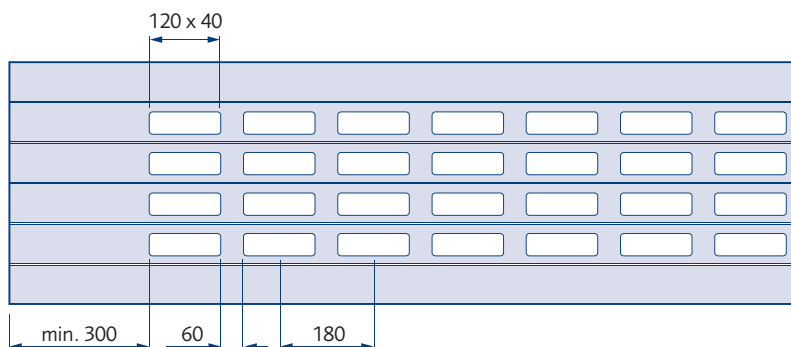

**Packaging**

GaraRoll doors are supplied in a palletted format shrink wrapped as a complete package.

**Stock availability**

All GaraRoll doors are made to order with no standard sizes. Lead-time for all doors is 3 to 4 weeks.

**Remember the GaraRoll door is measured as opening size and not as overall guide width.**

This not only makes it the same as all other Garador doors for sizing but also will probably reduce the price against other doors as most other door manufacturers calculate the price as over guide width thus making the actual door around 220 mm smaller!

Minimum product dimension is 1000 mm x 1600 mm.

■ Only the door prices highlighted are available with the external roller garage door fitting as an option.

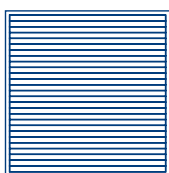

**Smooth paint finish**

Door width

Door height	1000	1250	1500	1750	1900	2000	2250	2500	2750	3000	3250	3500	3750	4000	4250	4500	4750	5000	5250	5500	5750	6000	
1600																							
1800		2578	2578	2670	2670	2696	2839	2934	3032	3072	3315	3413	3818	3906	4076	4166	4263	4357	4673	4769	4865	4960	
2000		2578	2578	2670	2670	2696	2839	2934	3032	3072	3315	3413	3818	3906	4076	4166	4263	4357	4673	4769	4865	4960	
2125		2578	2578	2670	2670	2791	2963	3009	3088	3173	3426	3534	3973	4010	4246	4340	4437	4530	4845	4939	5035	5129	
2250		2578	2578	2670	2670	2837	3050	3119	3185	3302	3594	3953	4102	4138	4363	4453	4549	4641	4956	5047	5137	5229	
2375		2578	2578	2670	2670	2837	3050	3119	3185	3302	3594	3953	4102	4138	4363	4453	4549	4641	4956	5047	5137	5229	
2500		2750	2750	2894	2894	2933	3100	3198	3314	3405	3711	4099	4175	4335	4507	4603	4695	4787	5102	5191	5284	5376	
2625		2750	2750	2894	2894	3027	3187	3287	3408	3531	4084	4250	4396	4542	4653	4750	4840	4932	-	-	-	-	
2675		2750	2750	2894	2894	3027	3187	3287	3408	3531	4084	4250	4396	4542	4653	4750	4840	4932	-	-	-	-	
2750		-	-	-	-	-	3187	3287	3408	3531	4084	4250	4396	4542	-	-	-	-	-	-	-	-	
2875		-	-	-	-	-	3321	3405	3509	3594	4201	4343	4517	4606	-	-	-	-	-	-	-	-	
3000		-	-	-	-	-	3321	3405	3509	3594	4201	4343	4517	4606	-	-	-	-	-	-	-	-	
3100		-	-	-	-	-	3321	3405	3509	3594	4201	4343	4517	4606	-	-	-	-	-	-	-	-	

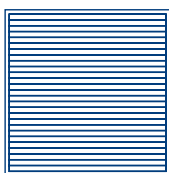

**Deco paint finish**

Door width

Door height	1000	1250	1500	1750	1900	2000	2250	2500	2750	3000	3250	3500	3750	4000	4250	4500	4750	5000	5250	5500	5750	6000	
1600																							
1800		2639	2654	2762	2777	2812	2962	3072	3184	3240	3498	3612	4032	4135	4320	4425	4538	4648	4977	5090	5201	5311	
2000		2647	2664	2773	2791	2827	2977	3088	3204	3261	3521	3636	4059	4164	4351	4458	4572	4684	5016	5130	5243	5354	
2125		2654	2673	2785	2804	2936	3115	3181	3279	3383	3655	3783	4240	4297	4551	4664	4780	4893	5226	5340	5454	5568	
2250		2659	2680	2792	2812	2992	3213	3302	3388	3525	3837	4216	4386	4442	4687	4798	4914	5026	5362	5473	5583	5695	
2375		2664	2686	2799	2821	3001	3222	3313	3401	3538	3852	4232	4403	4460	4706	4818	4935	5049	5385	5499	5609	5722	
2500		2840	2863	3030	3052	3105	3281	3402	3541	3654	3982	4393	4492	4675	4869	4988	5103	5217	5555	5667	5783	5897	
2625		2845	2869	3037	3061	3208	3378	3502	3647	3794	4371	4560	4729	4899	5034	5156	5270	5385	-	-	-	-	
2675		2851	2875	3044	3069	3217	3388	3513	3658	3807	4385	4576	4746	4918	5054	5175	5292	5408	-	-	-	-	
2750		-	-	-	-	3221	3391	3517	3663	3813	4390	4582	4753	4925	-	-	-	-	-	-	-	-	
2875		-	-	-	-	3267	3531	3641	3771	3883	4516	4684	4885	4999	-	-	-	-	-	-	-	-	
3000		-	-	-	-	3276	3541	3652	3783	3896	4530	4699	4901	5017	-	-	-	-	-	-	-	-	
3100		-	-	-	-	3284	3550	3662	3795	3909	4544	4715	4918	5035	-	-	-	-	-	-	-	-	

Deco paint only available in Golden Oak, Anthracite Metallic (Noir 2100 Sable) or Rosewood finish.

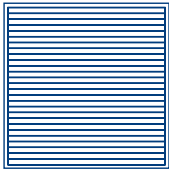

## Timber effect finish

Door height	Door width																						
	1000	1250	1500	1750	1900	2000	2250	2500	2750	3000	3250	3500	3750	4000	4250	4500	4750	5000	5250	5500	5750	6000	
1600																							
1800	2692	2720	2841	2870	2912	3067	3190	3316	3385	3657	3783	4216	4333	4531	4650	4775	4898	5241	5367	5491	5614		
2000	2706	2738	2863	2895	2939	3096	3222	3352	3424	3699	3829	4266	4386	4588	4710	4838	4965	5312	5442	5570	5696		
2125	2720	2756	2883	2920	3062	3247	3329	3444	3564	3853	3997	4471	4544	4815	4944	5076	5206	5555	5686	5817	5947		
2250	2729	2767	2897	2935	3124	3353	3459	3563	3718	4047	4444	4631	4705	4967	5096	5229	5359	5712	5841	5968	6098		
2375	2738	2778	2910	2950	3141	3371	3480	3586	3741	4074	4473	4662	4738	5002	5133	5269	5401	5756	5888	6017	6149		
2500	2918	2961	3147	3189	3254	3438	3578	3736	3869	4217	4648	4766	4968	5182	5320	5455	5589	5947	6077	6213	6347		
2625	2928	2972	3161	3205	3364	3543	3688	3853	4021	4618	4828	5018	5208	5364	5506	5641	5777	-	-	-	-		
2675	2937	2983	3174	3220	3382	3561	3707	3874	4045	4645	4857	5049	5242	5400	5543	5681	5819	-	-	-	-		
2750	-	-	-	-	3388	3568	3716	3884	4055	4655	4868	5062	5256	-	-	-	-	-	-	-	-		
2875	-	-	-	-	3439	3713	3844	3998	4132	4788	4978	5202	5339	-	-	-	-	-	-	-	-		
3000	-	-	-	-	3455	3730	3865	4020	4157	4815	5007	5233	5372	-	-	-	-	-	-	-	-		
3100	-	-	-	-	3473	3748	3885	4042	4181	4840	5036	5264	5406	-	-	-	-	-	-	-	-		

Timber Effect Foil Coat only available in Golden Oak and Rosewood finish.

### Options for GaraRoll doors

	add
Surcharge for different colour frame and guides to door colour	171
Manually operated version (not possible on external fit)	Price reduction 261
Removal of barrel casing (optional only on door height 2500 mm and over)	Price reduction per m 27
External fit (reverse rolled)	119
Chamfered bottom profile available only in White or Colour. Not available in timber effect finish	per m 490
Ventilation grilles or Glazing element with clear synthetic pane, window section 120 x 40 mm, black glazing frame on exterior, transparent on interior (maximum of 10 sections per door, number of glazing elements dependent on the door width) <sup>1</sup>	per m 44

<sup>1</sup> Not available in top 6 laths.

### Accessories for GaraRoll operator

	add
Bi-directional hand transmitter, 5-channel in black	96
Bi-directional hand transmitter mini, 4-channel in black	82
Motor connection line, 10 m - Reference No. 5498	42
Acoustic door security kit - Reference No. 8671	93
Emergency battery HNA 18 - Reference No. 8126	291
Exterior emergency release has two choices:	Internal fit 140
	External fit 167
Additional fascia panel required when fitting a door within the opening, ordering size will need to be door size plus guide width (price per metre) supplied in colour to match the door / guides	80

All other operator accessories can be combined with GaraRoll roller doors. Please see page 73 to page 76.

GaraRoll is also available with a colour door curtain and white guide rails and box cover, at an additional cost of £ 166. If required, please state clearly on your order.



## Roller door fitting dimensions

### Fitting behind the opening

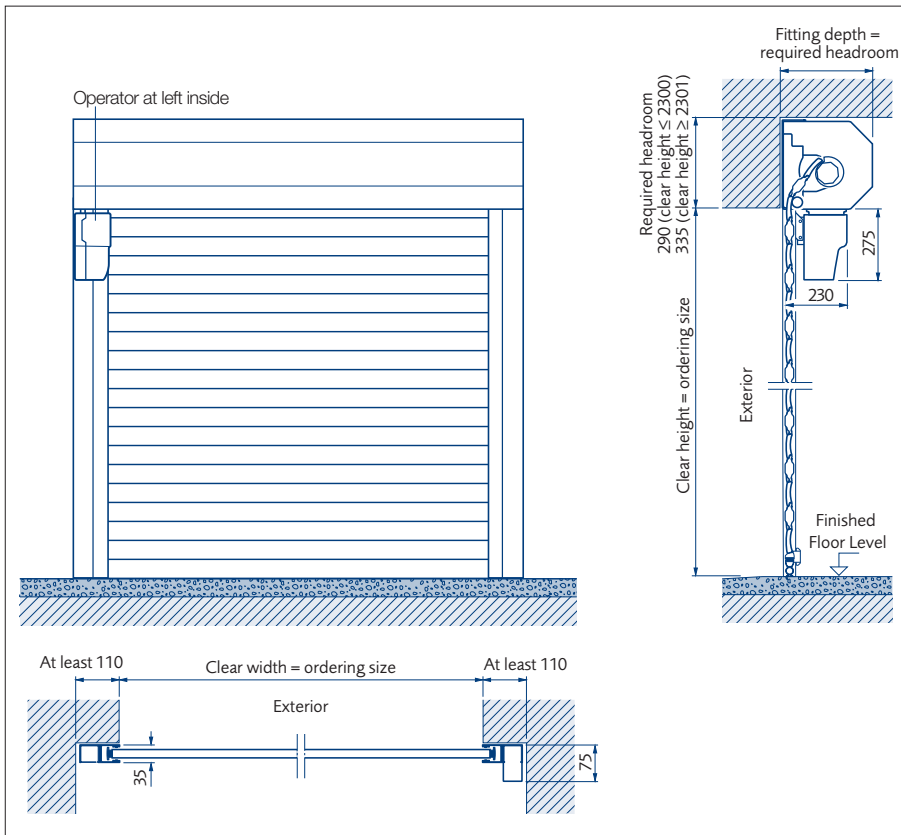

### Fitting in the opening

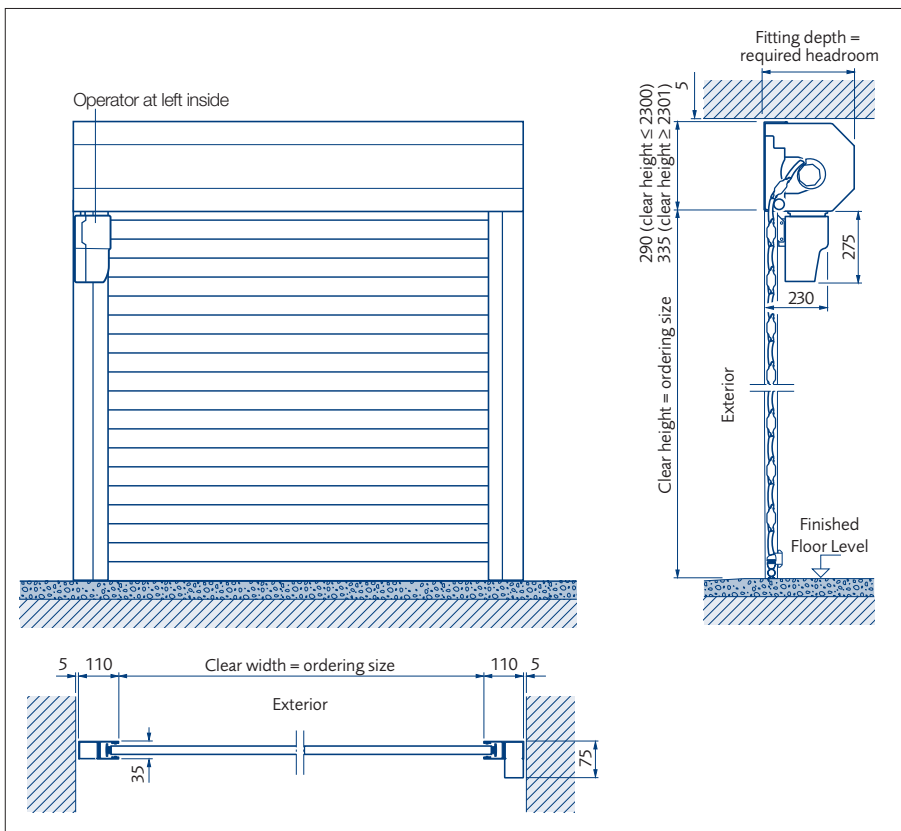

GaraGlide Roller Doors

# GaraGlide Roller Doors

A motor driven, roller garage door with tubular drive motor, closing edge safety device and manual hand crank for emergencies. The emergency release kit is not available for a retro-fit application so must be ordered with the original door. All doors are built to suit the opening, with the actual door size relating to the structural opening width x height and the guides fitting on the reveals to maintain a full opening size. Please refer to sizing tables for full range of size options.

## Door Curtain

77 mm rolled aluminium profile with 100 % CFC-free polyurethane rigid foam. Available in 16 standard colour, with a two-layer paint finish using a high-quality polyurethane paint coated with a polyimide. Each lath is 15 mm thick.

## Frame and Construction

75 mm guide rails for single doors and 105 mm for double doors. Guide rails are supplied in a colour to match the door curtain and with an integrated brush strip either side. The box cover, rollers and barrel are pre-assembled for convenience. Please state on your order if fitting between or behind opening.

## Operator and Control

GaraGlide operator and control included. 24 V DC gear drive, mains voltage 230 - 240 V AC, 0.5 KW, anti-lift kit, operator built into tubular drive with control board located on right as standard (viewed from inside) and impulse control. Operator with mechanically adjustable end-of-travel position. Included: 2 x bisecur 868 MHz hand transmitters and integral receiver, connecting lead with CEE plug, control buttons in cover of the control unit, integrated 2-minute garage courtesy light in control housing. The motor can be fitted either side. Also features an adjustable reversing procedure, adjustable pre-warning phase, adjustable automatic timer, connection of external illumination is possible and there is also a connecting option for a one-way photo cell.

## Standard Colours

GaraGlide roller doors are available in a choice of 15 standard colours, with the door curtain interior and exterior painted the same colour:

- |                            |                              |                          |                              |
|----------------------------|------------------------------|--------------------------|------------------------------|
| - Traffic White (RAL 9016) | - Steel Blue (RAL 5011)      | - Light Grey (RAL 7035)  | - Jet Black (RAL 9005)       |
| - Light Ivory (RAL 1015)   | - Moss Green (RAL 6005)      | - Agate Grey (RAL 7038)  | - White Aluminium (RAL 9006) |
| - Ruby Red (RAL 3003)      | - Slate Grey (RAL 7015)      | - Terra Brown (RAL 8028) | - Grey Aluminium (RAL 9007)  |
| - Purple Red (RAL 3004)    | - Anthracite Grey (RAL 7016) | - Cream (RAL 9001)       | - Chartwell Green            |

Anthracite Metallic (Noir 2100 Sable) is also available at an additional cost. See page 83 for additional colour options.

## Timber Effect Colours

A timber effect version is available in Golden Oak or Rosewood effect, where the exterior door curtain is coated in a UV-resistant synthetic foil with a timber effect design and embossed grain, and the interior of the door curtain is painted in Terra Brown (RAL 8028). A Deco Paint version is also available at a lower cost, where the laths are painted in a Golden Oak or Rosewood effect.

## Fitting

The GaraGlide is suitable for fitting between and behind a prepared brickwork opening.

## Packaging

GaraGlide roller doors are supplied in two twin-walled cardboard boxes for ease of transportation to site.

## Stock Availability

All GaraGlide doors are made to order with no standard sizes. Lead-time for all doors is 4 weeks.

Size range

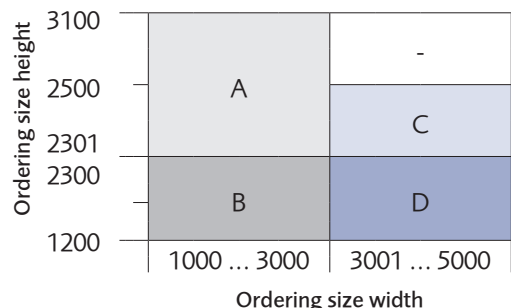

- A** Box 335, 75 mm guide rail, 70 mm shaft, no wind locks.
- B** Box 290, 75 mm guide rail, 70 mm shaft, no wind locks.
- C** Box 335, 105 mm guide rail, 80 mm shaft, with wind locks.
- D** Box 290, 105 mm guide rail, 80 mm shaft, with wind locks.

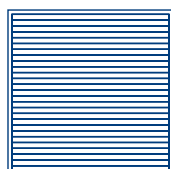

Smooth paint finish

Door height	Door width																		
	1000	1250	1500	1750	1900	2000	2250	2500	2750	3000	3250	3500	3750	4000	4250	4500	4750	5000	
1200																			
1500	2230	2283	2310	2363	2363	2415	2466	2516	2590	2975	3028	3080	3126	3179	3245	3294	3349		
1750	2267	2322	2360	2419	2419	2477	2535	2594	2670	3066	3124	3179	3234	3294	3365	3420	3480		
2000	2294	2357	2404	2466	2466	2527	2586	2646	2733	3137	3196	3260	3322	3383	3461	3519	3582		
2125	2305	2367	2415	2477	2477	2538	2604	2666	2748	3158	3222	3283	3349	3410	3489	3549	3617		
2250	2322	2391	2439	2504	2504	2570	2640	2704	2789	3204	3271	3336	3404	3468	3549	3617	3681		
2375	2352	2423	2477	2545	2545	2621	2691	2762	2852	3271	3339	3410	3480	3656	3740	3809	3883		
2500	2363	2434	2491	2562	2562	2631	2708	2780	2872	3294	3368	3438	3514	3687	3774	3849	3917		
2625	2404	2482	2541	2621	2621	2701	2780	2856	2957	3386	3464	3542	3621	3713	3782	3877	-		
2675	2404	2482	2541	2621	2621	2701	2780	2856	2957	3386	3464	3542	3621	3713	3782	-	-		
2750	2404	2482	2541	2621	2621	2701	2780	2856	2957	3386	3464	3542	3621	3713	3782	-	-		
2875	2439	2527	2594	2674	2674	2762	2844	2930	3039	3582	3662	3748	3833	3934	-	-	-		
3000	2439	2527	2594	2674	2674	2762	2844	2930	3039	3582	3662	3748	3833	-	-	-	-		
3100	2439	2527	2594	2674	2674	2762	2844	2930	3039	3582	3662	3748	3833	-	-	-	-		

Additional Colour Options

Standard colours (choice of 15 colour options)	Included	
Anthracite Metallic (Noir 2100 Sable)	per m <sup>2</sup>	41
Deco Paint (painted timber effect design in Golden Oak or Rosewood)	per m <sup>2</sup>	41
Timber effect (plastic film coating in Golden Oak or Rosewood timber effect)	per m <sup>2</sup>	74

Add £ 73 surcharge for external fit GaraGlide roller door.

Add £ 175 surcharge, to request the door curtain in one colour and the guide rails/box cover in an alternative colour. Please note there is no additional charge for a white frame.

Example of paint cost calculation:

For door dimensions of 2000 mm x 2125 mm, the door area is 4.25 m<sup>2</sup> (i.e. 2 x 2.125 = 4.25).

Multiply door area by cost per m<sup>2</sup> to calculate additional paint cost (i.e. 4.25 x 41 = £ 174.25).

Please note, dark colours should not be used for doors that are exposed to the sun. Despite the use of state-of-the-art colour coating systems, we cannot rule out colour deviations, specifically in metallic colours (RAL 9006 and RAL 9007).

Please state on your order if fitting between or behind opening.

External fit GaraGlide roller doors are only available up to 5000 mm wide and are not available in a timber effect finish.

GaraGlide is also available with a colour door curtain and white guide rails and box cover, at no extra charge. If required, please state clearly on your order.

## Roller door fitting dimensions

### Fitting behind opening

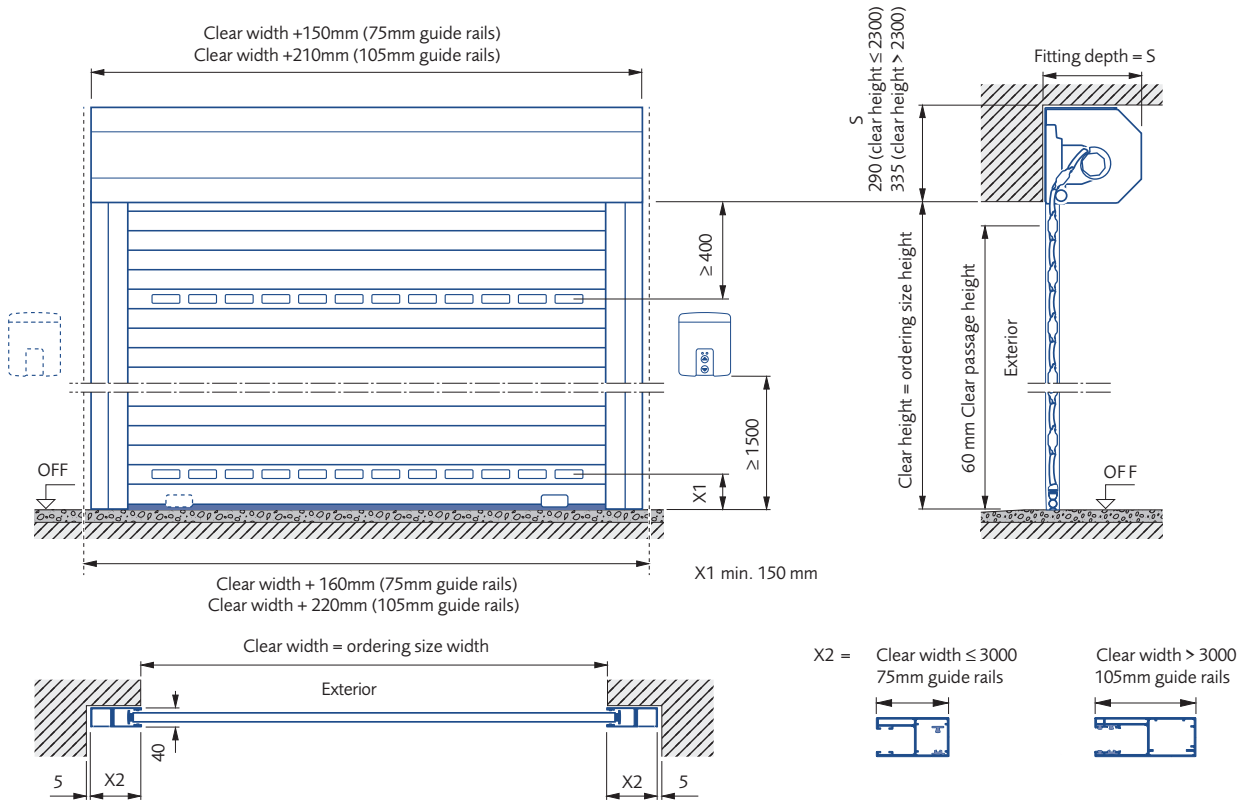

### Fitting between opening

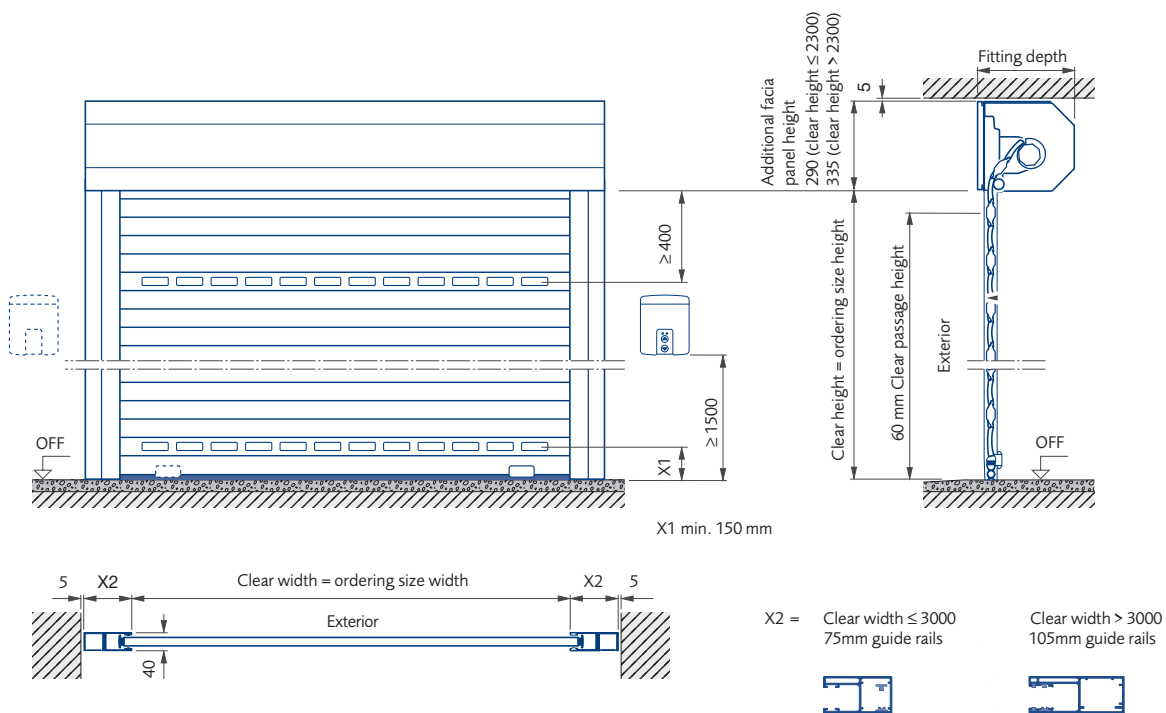

## Options for all GaraGlide roller garage doors

### Emergency Release

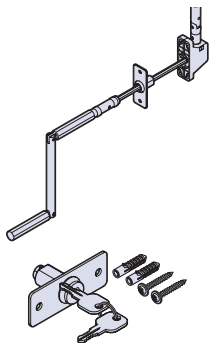

Exterior emergency release kit  
(Please note: the emergency release kit is not available for a retro-fit application so must be ordered with the original door).

each

289

### Ventilation Grilles and Glazing Elements



Glazing element (clear synthetic pane, window cut-out 112 mm x 33 mm)

per m

45



Ventilation grilles (black plastic with ventilation cross section approx 13 cm<sup>2</sup> / grille)

per m

45

### Additional Fascia Panel

Reinforcement of the fascia panel (required for fitting between opening)

per m

102

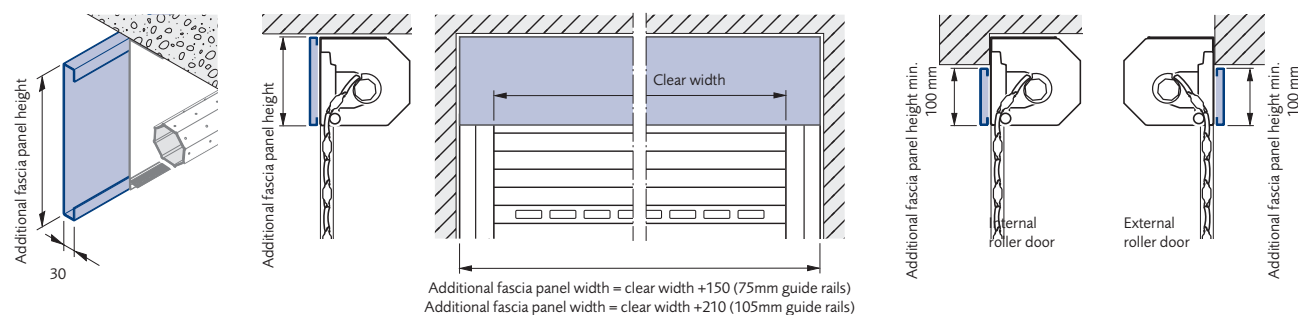

External fit (reverse rolled)

70

Operator with electronically adjustable end-of-travel positions

453

Wireless optical sensor

246

DuraBelt is available as an option when purchased with a new GaraGlide, or for retro-fitting to an existing GaraGlide:

#### DuraBelt (Optional)

1000 mm - 1600 mm wide (2 winding units)	surcharge per door	95
1601 mm - 3000 mm wide (3 winding units)	surcharge per door	141
3001 mm - 5000 mm wide (5 winding units)	surcharge per door	235

#### DuraBelt (Retro-Fitted)

up to 2300 mm wide (2 winding units)	per door	143
up to 2300 mm wide (3 winding units)	per door	215
from 2301 mm wide (2 winding units)	per door	143
from 2301 mm wide (3 winding units)	per door	215

# User Information / Care

A Garador garage door needs only a minimum level of preparation and maintenance to give years of trouble-free service. Below is a guide to how to get the best from your garage door.

## Operation

- For opening the door in manual operation use only the outside handle or inside handle. Never use the pull rope during the opening cycle of the door.
- For closing the door from the outside – the pull rope fixed to the internal handle is only designed to pull the door towards you whilst standing within the entrance of the garage until the door can be pushed down by hand, then using the external handle for final closing.
- For closing the door from the inside – the pull rope already mentioned is designed to be pulled away from you, when facing the front entrance of the garage, until the internal handle is able to be reached, by hand, and used for final closing. The pull rope is not designed to be used for any other part of the operating cycle, or any other purpose. Failure to comply with the above instructions may result in injury to persons or property.
- When the door is operated from either outside or inside, check the area through which the door will travel is clear from people and objects. Failure to do so may result in injury to persons or property.
- When closing, ensure the latches engage properly.
- If the door is power-operated always try to ensure you match the door with a GaraMatic electric operator.

## Power Operated Garage Doors

- It is against the Law to install a power operated garage door in the UK without complying with The Machinery Directive.
- To comply with the Machinery Directive both the door and the operator used in the Installation must have a declaration of Incorporation from the manufacturer.  
On completion of the installation the Installer must provide a Declaration of conformity and apply a CE mark giving details of the installation to the door/operator combination, which is now classed as a machine.
- The Installer must issue to the Customer a declaration of conformity on the completion of the installation.
- The Installer must hold copies of both the Declarations of Incorporation and the Declaration of Conformity on a technical file for inspection by the relevant authorities.
- If any of the above requirements are not fulfilled the Installation is illegal.
- Please ensure for your own safety and peace of mind that whoever installs your electric operator is both willing and able to fulfil these requirements; if they are not do not use them !!
- Members of the DHF CAN and WILL install your operator safely and legally.

## Cleaning

- The door and frame if applicable, should be washed with a mild soap-based solution on a regular basis to prevent the build up of dirt, salts and other corrosive substances and help maintain the aesthetic appearance of the product.
- If the door is installed in a coastal location, the door panel and frame should be cleaned in this way at least every two months.
- We also suggest that all other components be brushed down on a regular basis to prevent the build up of dirt and dust etc.
- On GaraRoll roller doors regular removal of dirt and debris is required to avoid damage to laths when the curtain rolls.

## Locking

- If the key is turned completely, the door is then locked or unlocked; when unlocked it is then possible to open and close the door by turning the handle.
- If the key is turned 1/4 of the way, the door opened and then the key returned to its start position, the door will re-lock when closed.
- By moving the internal locking "snib", it is possible to lock and unlock the door from the inside without using the key, except on SBD doors where there is no internal snib/locking system.

## Maintenance

- If in doubt about any of these maintenance procedures below always consult a Garador specialist. Garador Ltd. has a nationwide network of installers who will be able to offer you a regular maintenance service on your garage door. Please call Garador or refer to the Garador website for further details of your nearest installer.
- Immediately after the door is fitted and after every 5,000 operations of the door, or at least once a year, oil all pivot points, check screws and clamped connections for tightness, keep the running tracks clean (do not grease them), check parts and replace any worn components where necessary.
- The springs should be replaced after approx. 25,000 operations by an experienced door fitter (see fitting and operation instructions).
- Do not oil the lock cylinder; if it is sticking, only lubricate with graphite dust.
- For canopy doors only, check the cable every 6 months with normal usage (8 operations per day). Have the cables replaced by an expert if any wear is found.

#### **Finish – Steel Doors**

The coating process applied to the door and chassis is environmentally friendly. Minor scratches or marks are not covered under the conditions of our warranty and should be repaired immediately to prevent corrosion and deterioration of the panel. Corrosive substances such as acids, alkalines, and salts, etc. should be cleaned from the door immediately; failure to do so will result in deterioration of the finish, which will not be covered under our warranty. Garador steel doors are finished products. They do not require immediate painting on-site. They are however not immune to damage, which can occur at any stage of the handling of the product from factory to site. Should deterioration of the finish start to occur you will need to repaint your door immediately. Prepare the surface lightly with wet and dry. Then treat with solvent based 2 pack epoxy wash primer and a normal commercial paint (cellulose paint must not be used).

Minor surface damage can easily be repaired using touch up sprays or paint sticks without invalidating your warranty.

#### **Finish – Timber Doors**

Timber panels are coated with a neutralising base-stain. Doors must be stored upright, under cover in a dry location, with wrapping intact, until wrapping is removed. As soon as the door is unwrapped, one coat of a good quality basecoat primer must be applied to both sides of the door.

Immediately after installation, your timber doors require a further two coats of a good quality exterior wood finish on both sides.

Initial application and periodic treatment should be carried out strictly in accordance with the woodstain manufacturer's instructions.

Failure to follow these instructions will result in early deterioration of the timber panel which would not be covered under our warranty.

#### **Finish – GRP Doors**

GRP door panels should be periodically washed down using water. This should be done more frequently if fitted in a coastal location.

Bird droppings will bleach the finish on GRP and should be removed using water as soon as possible.

GRP doors should not be painted over.

# Warranty

Garador products are manufactured to the highest quality standards and leave our factory only after rigorous quality testing. However, if you should have grounds for complaint, this section tells you what our door warranty offers, and how to go about making your claim.

In the unlikely event of a warranty claim becoming necessary, please contact the dealer or distributor who originally supplied your garage door. Your dealer should then supply details of the claim, together with a copy of the warranty card provided with the door and proof of purchase to the Warranty Department at Garador Ltd.

To enable your claim under warranty to be processed as quickly as possible, you should provide the following details:

- 1 Your name, address and telephone number
- 2 Original invoice with date of purchase
- 3 Product description/door type and product number
- 4 Description of defect

An assessment of the claim will then be made. This may require Garador to inspect the product in-situ. In the event that there is no legitimate warranty claim under the terms specified herein, you may be liable for the costs of the inspection visit. We strongly recommend that you take note of the care and usage instructions displayed on the stickers on the back of your garage door and on the previous page and that you follow these instructions throughout.

## Garador installers

Garador Ltd. has a nationwide network of recommended installers who will be able to offer you a regular maintenance service on your garage door. Please call us on 01935 443722 or refer to the Garador website for further details of your nearest installer.

## Garador Garage Door Warranty

### Warranty Period

The purchaser is granted a warranty covering the safe and reliable function of the Garador garage door for a period of 10 years from the date of purchase. A 5 year warranty applies to springs, wire cables, track rollers, hinges and guide rollers. The warranty period for replacement parts is 6 months or to the end of the current warranty period, whichever is longer.

In the case of foil-coated timber effect and PVC doors, a warranty of 5 years is granted, for timber and GRP doors a warranty of 2 years is granted on the door panels alone under the terms and conditions specified herein. The door mechanism and steel frame (if applicable) is covered by the 10 year warranty period.

### Requirements

Warranty claims are only applicable in the country where the garage door was purchased. The product must have been purchased through our authorised distribution channels. The warranty only covers damage to the contract object. The fully completed warranty card together with the receipt of purchase correspondingly dated substantiates your right to claim under the warranty.

### Performance

During the warranty period we undertake to rectify any and all defects to the Garador product which can be proved to be attributed to a material or manufacturing fault.

We pledge at our discretion either to exchange the defective merchandise for faultless merchandise, repair it or allow a reduction in price. We do not accept costs for dismantling and installation nor for carriage.

Replaced parts become our property.

The warranty does not cover damage caused through:

- normal wear and tear
- improper installation
- negligent care and maintenance
- improper initial and subsequent operation
- negligent or wanton destruction
- external influences such as fire, water, salts, alkaline solutions, acids, abnormal environmental influences
- mechanical damage through improper transport and fitting
- priming and other surface protection treatments
- incorrect or too late applied surface protection treatments
- repair by non-qualified persons
- using non-Garador parts without the approval of the manufacturer
- Removal of the product number or making it unidentifiable

### Warranty GaraRoll and GaraGlide

GaraRoll and GaraGlide roller doors are subject to a limited 10 year warranty. The design of these doors represents state of the art technology. Pressure marks and abrasive wear, particularly on the top profiles are a condition of the design and cannot be avoided. They are not considered a reason for complaint.

In order to avoid excessive friction, remove any dirt and debris from the door curtain at regular intervals. For motors and controls, see warranty below.



## GARADOR Warranty

In addition to the statutory warranty provided by the dealer in the sales contract, we grant the following warranty for parts from the date of purchase:

- 5 years on operator technology, motor and motor control.
- 2 years on radio equipment, accessories and special systems.

Claims made under the warranty do not extend the warranty period. For replacement parts and repairs the warranty period is six months or at least the remainder of the warranty period.

General wear and tear:

Due to the design of the roller door, the inside of the door curtain will exhibit some marks after a short period of time. This is classed as general wear and tear that you would expect to see over a period of months or years. It is not detrimental to the door's performance and would therefore not be grounds for a warranty claim.

Pre-requisites:

The warranty claim only applies in the country where the equipment was purchased. The product must have been purchased through our authorised distribution channels. A claim under this warranty exists only for damage to the object of the contract itself. The receipt of purchase substantiates your right to claim under the warranty.

Services:

For the duration of the warranty we shall eliminate any product defects that are proven to be attributable to a material or manufacturing fault.

We pledge to replace free of charge and at our discretion the defective goods with non-defective goods, to carry out repairs, or to grant a price reduction. Replaced parts become our property. Reimbursement of expenditure for dismantling and fitting, testing of parts as well as demands for lost profits and compensation for damages are excluded from the warranty.

Damage caused by the following is also excluded:

- improper fitting and connection
- improper initial start-up and operation
- external factors such as fire, water, abnormal environmental conditions
- mechanical damage caused by accidents, falls, impacts
- negligent or intentional destruction
- normal wear or deficient maintenance
- repairs conducted by unqualified persons
- use of non-original parts
- removal or defacing of the data label

### Electric Operator Warranty

A separate 5 year warranty is granted on our electric operators. This includes operator mechanics, motor and motor control systems. A 2 year warranty is granted on radio equipment, accessories and system controls. There is no warranty on consumables (e. g. fuses, batteries, bulbs etc.).

For further details please contact us on 01935 443722, or through our website on [www.garador.co.uk](http://www.garador.co.uk)

# Extracts from DHF consumer advice

The following document has been created by the Door and Hardware Federation (DHF) and endorsed by all major UK garage door manufacturers, as a guide for purchasers and domestic garage doors.

## Visual Appearance of Garage Doors

A new garage door can be a significant investment that will transform the appearance of your home. This information is a guide to the quality you can expect.

### The Quality Check

The quality check should be carried out in natural daylight, not direct sunlight. Stand at a distance of 3 metres from the door to view the overall appearance. The door is acceptable if, taking into account the facts below, none of the following are readily visible on the face of the door:

- Marks or distortion associated with the manufacturing process
- Minor indentations, marks or scuffs on the surface
- Paint or stain blemishes

## The Facts

### Steel Doors

- Panel Distortion

The rolling or pressing of steel panels during manufacture will cause distortion in the steel and while every effort is made to keep this to a minimum, inevitably some visible distortion will remain. The application of high gloss paints will make this slight distortion more apparent, especially under certain lighting conditions, such as car headlamps, or bright sunshine.

- Paint Finish

Primed doors – the primer coating is applied as a base coat only and as such requires additional finishing with a good quality exterior paint.

Any marks or scratches on the primer coat should be rubbed down and repainted as part of this finishing process.

Finished doors – the factory application of the paint finish is an automated process and this may result in minor blemishes or slight inconsistencies in the paint, particularly in the area of panel joints.

### Timber Doors

- Timber

Timber is a natural product and there will be variations in pattern, colour, shading and grains. No two doors will be the same. Wood naturally expands and contracts according to environmental conditions, joints will open and close and some minor curvature may occur.

- Finishing

It is vital that timber doors are fully finished as per the manufacturers instructions before exposure to the elements.

### GRP and composite Plastic Doors

- Mould Marks

GRP doors are individually handcrafted in a mould and are then hand finished. Some minor marks and blemishes will inevitably remain after this process.

- Translucency

When viewed from the inside, it is often possible to see variations in the translucency of the door, particularly around and between areas of relief. Such variations do not detract from the overall strength or build quality of the door.

### All Doors

- Colour Match

Pairs of doors should be ordered together to obtain the best colour match, bearing in mind the limitations of the materials used in the construction.

Timber garage doors cannot be ordered as matching sets.

- Size Variations

As the size of a door changes in height and/or width, the panel frequency and profile can change, therefore doors of the same style but of different sizes can be significantly different in appearance.

- Clearances

All doors require operating clearances, i.e. the gap between the door panel and the frame opening, these are inbuilt during manufacture and should not be reduced by means of infills, or draughtproofing.

- Deflection

When in the open position, all doors will display a level of vertical deflection or 'sag' across the width of the panel. Individual manufacturers' specifications should be consulted for exact tolerances.



# GARADOR

*The Garage Door People*

Bunford Lane, Yeovil, Somerset, BA20 2GL  
Tel: (01935) 443722 Fax: (01935) 443744

[www.garador.co.uk](http://www.garador.co.uk)



Garador is the UK's leading manufacturer of garage doors and operators, with an ultra-modern production facility located in Somerset. We use German engineering expertise to produce highly sophisticated doors and operators. By purchasing a Garador product you can be assured of the highest level of quality, safety and security. With a nationwide network of stockists, installers and service technicians we are an ideal partner for your project.